

CHAPTER 7

DISPOSAL METHODS

7.1 Introduction

Under the proper conditions, wastewater may be safely disposed of onto the land, into surface waters, or evaporated into the atmosphere by a variety of methods. The most commonly used methods for disposal of wastewater from single dwellings and small clusters of dwellings may be divided into three groups: (1) subsurface soil absorption systems, (2) evaporation systems, and (3) treatment systems that discharge to surface waters. Within each of these groups, there are various designs that may be selected based upon the site factors encountered and the characteristics of the wastewater. In some cases, a site limitation may be overcome by employing flow reduction or wastewater segregation devices (see Chapter 6). Because of the broad range of possible alternatives, the selection of the most appropriate design can be difficult. The site factor versus system design matrix presented in Chapter 2 should be consulted to aid in this selection.

Onsite disposal methods discussed in this chapter are:

1. Subsurface soil absorption systems
 - trenches and beds
 - seepage pits
 - mounds
 - fills
 - artificially drained systems
 - electro-osmosis
2. Evaporation systems
 - evapotranspiration and evapotranspiration-absorption
 - evaporation and evaporation-percolation ponds
3. Treatment systems that discharge to surface waters

Performance data and design, construction, operation, and maintenance information are provided for each of these methods.

7.2 Subsurface Soil Absorption

7.2.1 Introduction

Where site conditions are suitable, subsurface soil absorption is usually the best method of wastewater disposal for single dwellings because of its simplicity, stability, and low cost. Under the proper conditions, the soil is an excellent treatment medium and requires little wastewater pretreatment. Partially treated wastewater is discharged below ground surface where it is absorbed and treated by the soil as it percolates to the groundwater. Continuous application of wastewater causes a clogging mat to form at the infiltrative surface, which slows the movement of water into the soil. This can be beneficial because it helps to maintain unsaturated soil conditions below the clogging mat. Travel through two to four feet of unsaturated soil is necessary to provide adequate removals of pathogenic organisms and other pollutants from the wastewater before it reaches the groundwater. However, it can reduce the infiltration rate of soil substantially. Fortunately, the clogging mat seldom seals the soil completely. Therefore, if a subsurface soil absorption system is to have a long life, the design must be based on the infiltration rate through the clogging mat that ultimately forms. Formation of the clogging mat depends primarily on loading patterns, although other factors may impact its development.

7.2.1.1 Types of Subsurface Soil Absorption Systems

Several different designs of subsurface soil absorption systems may be used. They include trenches and beds, seepage pits, mounds, fills, and artificially drained systems. All are covered excavations filled with porous media with a means for introducing and distributing the wastewater throughout the system. The distribution system discharges the wastewater into the voids of the porous media. The voids maintain exposure of the soil's infiltrative surface and provide storage for the wastewater until it can seep away into the surrounding soil.

These systems are usually used to treat and dispose of septic tank effluent. While septic tank effluent rapidly forms a clogging mat in most soils, the clogging mat seems to reach an equilibrium condition through which the wastewater can flow at a reasonably constant rate, though it varies from soil to soil (1)(2)(3)(4). Improved pretreatment of the wastewater does not appear to reduce the intensity of clogging, except in coarse granular soils such as sands (4)(5)(6).

7.2.1.2 System Selection

The type of subsurface soil absorption system selected depends on the site characteristics encountered. Critical site factors include soil profile characteristics and permeability, soil depth over water tables or bedrock, slope, and the size of the acceptable area. Where the soil is at least moderately permeable and remains unsaturated several feet below the system throughout the year, trenches or beds may be used. Trenches and beds are excavations of relatively large areal extent that usually rely on the upper soil horizons to absorb the wastewater through the bottom and sidewalls of the excavation. Seepage pits are deep excavations designed primarily for lateral absorption of the wastewater through the sidewalls of the excavation; they are used only where the groundwater level is well below the bottom of the pit, and where beds and trenches are not feasible.

Where the soils are relatively impermeable or remain saturated near the surface, other designs can be used to overcome some limitations. Mounds may be suitable where shallow bedrock, high water table, or slowly permeable soil conditions exist. Mounds are beds constructed above the natural soil surface in a suitable fill material. Fill systems are trench or bed systems constructed in fill material brought in to replace unsuitable soils. Fills can be used to overcome some of the same limitations as mounds. Curtain or underdrain designs sometimes can be used to artificially lower groundwater tables beneath the absorption area so trenches or beds may be constructed. Table 2-1 presents the general site conditions under which the various designs discussed in this manual are best suited. For specific site criteria appropriate for each, refer to the individual design sections in this chapter.

7.2.2 Trench and Bed Systems

7.2.2.1 Description

Trench and bed systems are the most commonly used method for onsite wastewater treatment and disposal. Trenches are shallow, level excavations, usually 1 to 5 ft (0.3 to 1.5 m) deep and 1 to 3 ft (0.3 to 0.9 m) wide. The bottom is filled with 6 in. (15 cm) or more of washed crushed rock or gravel over which is laid a single line of perforated distribution piping. Additional rock is placed over the pipe and the rock covered with a suitable semipermeable barrier to prevent the backfill from penetrating the rock. Both the bottoms and sidewalls of the trenches are infiltrative surfaces. Beds differ from trenches in that they are wider than 3 ft (0.9 m) and may contain more than one line of distribution piping (see Figures 7-1 and 7-2). Thus, the bottoms of the beds are the principal infiltrative surfaces.

FIGURE 7-1
TYPICAL TRENCH SYSTEM

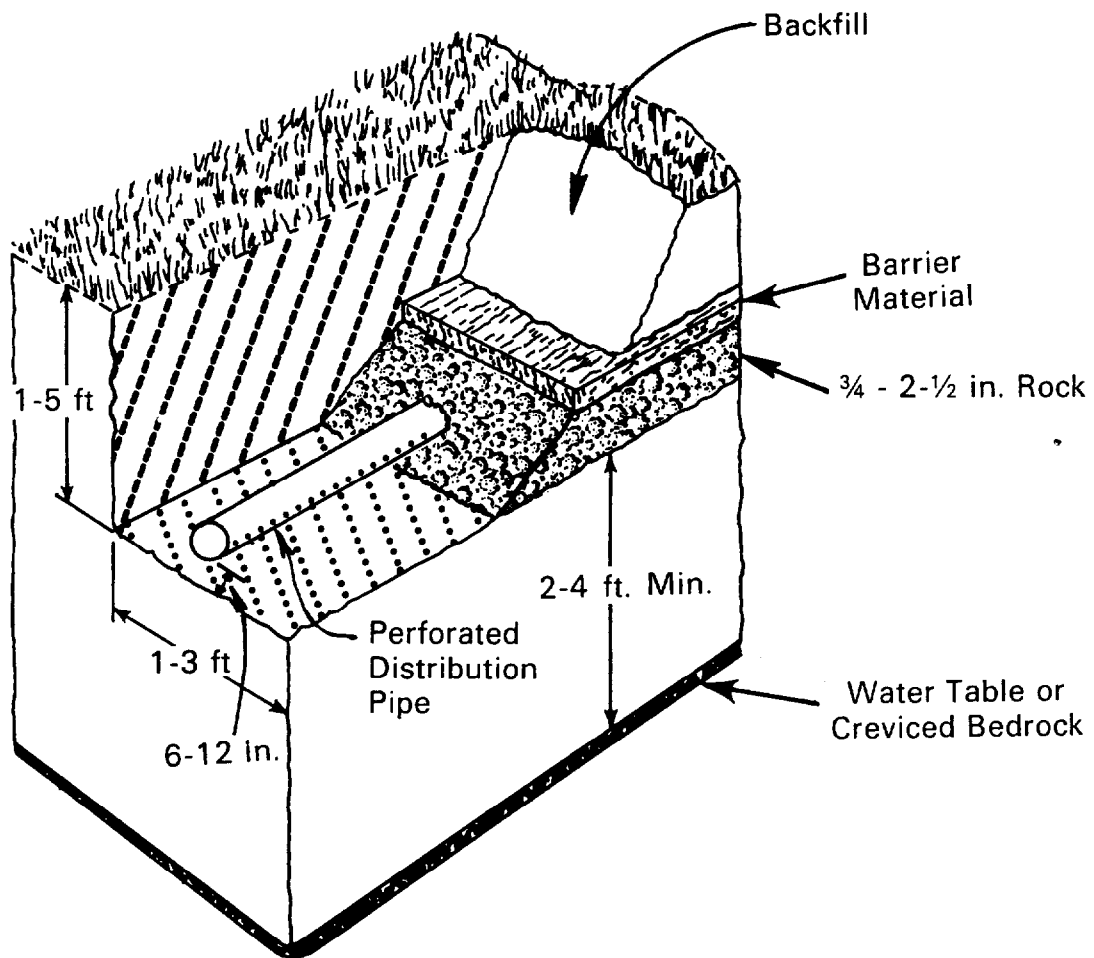
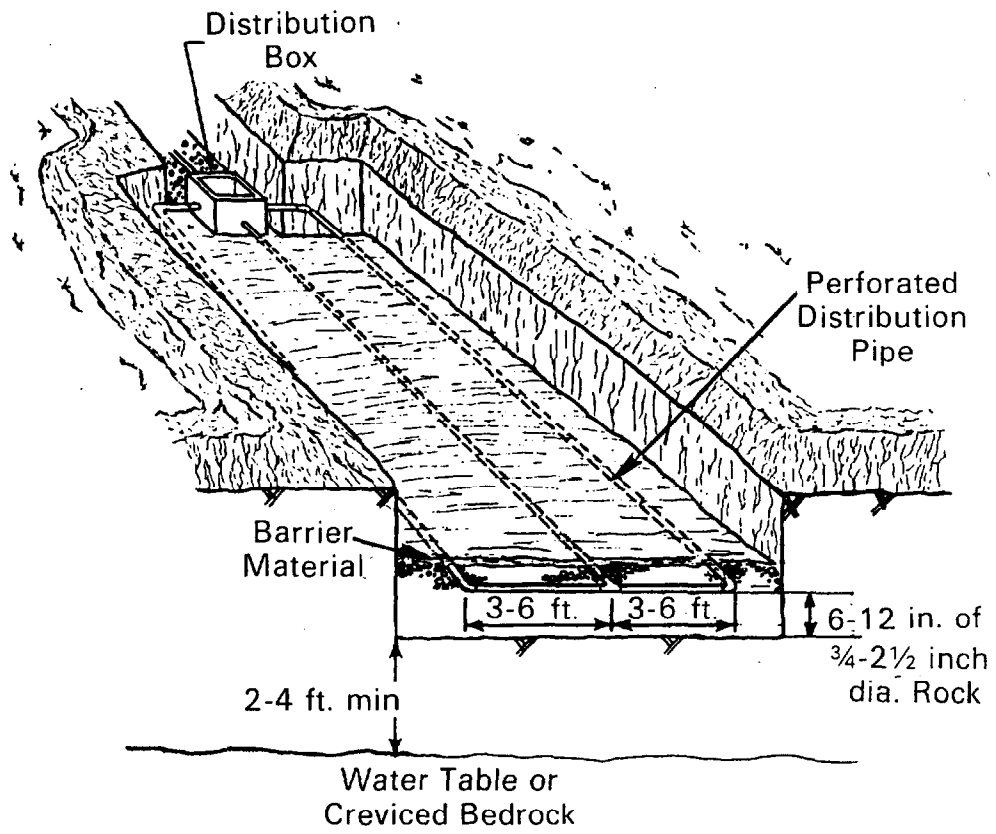

FIGURE 7-2
TYPICAL BED SYSTEM



7.2.2.2 Application

Site criteria for trench and bed systems are summarized in Table 7-1. They are based upon factors necessary to maintain reasonable infiltration rates and adequate treatment performance over many years of continuous service. Chapter 3 should be consulted for proper site evaluation procedures.

The wastewater entering the trench or bed should be nearly free from settleable solids, greases, and fats. Large quantities of these wastewater constituents hasten the clogging of the soil (9). The organic strength of the wastewater has not been well correlated with the clogging mat resistance except in granular soils (4)(5). Water softener wastes have not been found to be harmful to the system even when significant amounts of clay are present (9)(10). However, the use of water softeners can add a significant hydraulic load to the absorption system and should be taken into account. The normal use of other household chemicals and detergents have also been shown to have no ill effects on the system (9).

7.2.2.3 Design

a. Sizing the Infiltrative Surface

The design of soil absorption systems begins at the infiltrative surface where the wastewater enters the soil. With continued application of wastewater, this surface clogs and the rate of wastewater infiltration is reduced below the percolative capacity of the surrounding soil. Therefore, the infiltrative surface must be sized on the basis of the expected hydraulic conductivity of the clogging mat and the estimated daily wastewater flow (see Chapter 4).

Direct measurement of the expected wastewater infiltration rate through a mature clogging mat in a specific soil cannot be done prior to design. However, experience with operating subsurface soil absorption systems has shown that design loadings can sometimes be correlated with soil texture (3)(4)(11)(12). Recommended rates of application versus soil textures and percolation rates are presented in Table 7-2. This table is meant only as a guide. Soil texture and measured percolation rates will not always be correlated as indicated, due to differences in structure, clay mineral content, bulk densities, and other factors in various areas of the country (see Chapter 3).

TABLE 7-1

SITE CRITERIA FOR TRENCH AND BED SYSTEMS

| <u>Item</u> | <u>Criteria</u> |
|--|--|
| Landscape Position ^a | Level, well drained areas, crests of slopes, convex slopes most desirable. Avoid depressions, bases of slopes and concave slopes unless suitable surface drainage is provided. |
| Slope ^a | 0 to 25%. Slopes in excess of 25% can be utilized but the use of construction machinery may be limited (7). Bed systems are limited to 0 to 5%. |
| Typical Horizontal Separation Distances ^b | |
| Water Supply Wells | 50 - 100 ft |
| Surface Waters, Springs | 50 - 100 ft |
| Escarpments, Manmade Cuts | 10 - 20 ft |
| Boundary of Property | 5 - 10 ft |
| Building Foundations | 10 - 20 ft |
| Soil | |
| Texture | Soils with sandy or loamy textures are best suited. Gravelly and cobbly soils with open pores and slowly permeable clay soils are less desirable. |
| Structure | Strong granular, blocky or prismatic structures are desirable. Platy or unstructured massive soils should be avoided. |
| Color | Bright uniform colors indicate well-drained, well-aerated soils. Dull, gray or mottled soils indicate continuous or seasonal saturation and are unsuitable. |

TABLE 7-1 (continued)

| <u>Item</u> | <u>Criteria</u> |
|-------------------|--|
| Layering | Soils exhibiting layers with distinct textural or structural changes should be carefully evaluated to insure water movement will not be severely restricted. |
| Unsaturated Depth | 2 to 4 ft of unsaturated soil should exist between the bottom of the system and the seasonally high water table or bedrock (3)(4)(8). |
| Percolation Rate | 1-60 min/in. (average of at least 3 percolation tests). ^c Systems can be constructed in soils with slower percolation rates, but soil damage during construction must be avoided. |

^a Landscape position and slope are more restrictive for beds because of the depths of cut on the upslope side.

^b Intended only as a guide. Safe distance varies from site to site, based upon topography, soil permeability, ground water gradients, geology, etc.

^c Soils with percolation rates <1 min/in. can be used for trenches and beds if the soil is replaced with a suitably thick (>2 ft) layer of loamy sand or sand.

TABLE 7-2

RECOMMENDED RATES OF WASTEWATER APPLICATION
FOR TRENCH AND BED BOTTOM AREAS (4)(11)(12)^a

| <u>Soil Texture</u> | <u>Percolation Rate</u> min/in. | <u>Application Rate^b</u> gpd/ft ² |
|---|--|--|
| Gravel, coarse sand | <1 | Not suitable ^c |
| Coarse to medium sand | 1 - 5 | 1.2 |
| Fine sand, loamy sand | 6 - 15 | 0.8 |
| Sandy loam, loam | 16 - 30 | 0.6 |
| Loam, porous silt loam | 31 - 60 | 0.45 |
| Silty clay loam, clay loam ^d | 61 - 120 | 0.2 ^e |

^a May be suitable estimates for sidewall infiltration rates.

^b Rates based on septic tank effluent from a domestic waste source. A factor of safety may be desirable for wastes of significantly different character.

^c Soils with percolation rates <1 min/in. can be used if the soil is replaced with a suitably thick (>2 ft) layer of loamy sand or sand.

^d Soils without expandable clays.

^e These soils may be easily damaged during construction.

Conventional trench or bed designs should not be used for rapidly permeable soils with percolation rates faster than 1 min/in. (0.4 min/cm) (11). The rapidly permeable soils may not provide the necessary treatment to protect the groundwater quality. This problem may be overcome by replacing the native soil with a suitably thick (greater than 2 feet) layer of loamy sand or sand textured soil. With the liner in place, the design of the system can follow the design of conventional trenches and beds using an assumed percolation rate of 6 to 15 min/in. (2.4 to 5.9 min/cm).

Conventional trench or bed designs should also be avoided in soils with percolation rates slower than 60 min/in. (24 min/cm). These soils can be easily smeared and compacted during construction, reducing the soil's infiltration rate to as little as half the expected rate (12). Trench systems may be used in soils with percolation rates as slow as 120 min/in (47 min/cm), but only if great care is exercised during construction. Construction should proceed only when the soil is sufficiently dry to resist compaction and smearing during excavation. This point is reached when it crumbles when trying to roll a sample into a wire between the palms of the hands. Trenches should be installed so that construction machinery need not drive over the infiltrative surface. A 4- to 6-in. (10- to 15-cm) sand liner in the bottom of the trench may be used to protect the soil from compaction during placement of the aggregate and to expose infiltrative surface that would otherwise be covered by the aggregate (11)(13).

b. Geometry of the Infiltrative Surface

Sidewalls as Infiltrative Surfaces: Both the horizontal bottom area and the vertical sidewalls of trenches and beds can act as infiltrative surfaces. When a gravity-fed system is first put into service, the bottom area is the only infiltrative surface. However, after a period of wastewater application, the bottom can become sufficiently clogged to pond liquid above it, at which time the sidewalls become infiltrative surfaces as well. Because the hydraulic gradients and resistances of the clogging mats on the bottom and sidewalls are not likely to be the same, the infiltration rates may be different. The objective in design is to maximize the area of the surface expected to have the highest infiltration rate while assuring adequate treatment of wastewater and protection of the groundwater.

Because the sidewall is a vertical surface, clogging may not be as severe as that which occurs at the bottom surface, due to several factors: (1) suspended solids in the wastewater may not be a significant factor in sidewall clogging; (2) the rising and falling liquid levels in the system allow alternative wetting and drying of the sidewall while the bottom may remain continuously inundated; and (3) the clogging mat

can slough off the sidewall. These factors tend to make the sidewall clogging less severe than the bottom surface. However, the hydraulic gradient across the sidewall mat is also less. At the bottom surface, gravity, the hydrostatic pressure of the ponded water above, and the matric potential of the soil below the mat contribute to the total hydraulic gradient. At the sidewall, the gravity potential is zero, and the hydrostatic potential diminishes to zero at the liquid surface. Because the matric potential varies with changing soil moisture conditions, it is difficult to predict which infiltrative surface will be more effective.

In humid regions where percolating rainwater reduces the matric potential along the sidewall, shallow trench systems are suggested (4). The bottom area is the principal infiltrative surface in these systems. Shallow trenches often are best because the upper soil horizons are usually more permeable and greater evapotranspiration can occur. In dry climates, the sidewall area may be used to a greater extent. The bottom area may be reduced as the sidewall area is increased. Common practice is not to give credit to the first 6 in. (15 cm) of sidewall area measured from the trench bottom, but any exposed sidewall above 6 in. (15 cm) may be used to reduce the bottom area (3)(11). The infiltration rates given in Table 7-2 may be used for sidewall areas.

Trench versus Bed Design: Because beds usually require less total land area and are less costly to construct, they are often installed instead of trenches. However, trenches are generally more desirable than beds (4)(11)(12)(13)(14). Trenches can provide up to five times more sidewall area than do beds for identical bottom areas. Less damage is likely to occur to the soil during construction because the excavation equipment can straddle the trenches so it is not necessary to drive on the infiltrative surface. On sloping sites, trenches can follow the contours to maintain the infiltrative surfaces in the same soil horizon and keep excavation to a minimum. Beds may be acceptable where the site is relatively level and the soils are sands and loamy sands.

Shallow versus Deep Absorption Systems: Shallow soil absorption systems offer several advantages over deep systems. Because of greater plant and animal activity and less clay due to eluviation, the upper soil horizons are usually more permeable than the deeper subsoil. Also, the plant activity helps reduce the loading on the system during the growing season by transpiring significant amounts of liquid and removing some nitrogen and phosphorus from the waterwater. Construction delays due to wet soils are also reduced because the upper horizons dry more quickly.

On the other hand, deep systems have advantages. Increased depths permit increased sidewall area exposure for the same amount of bottom area. They also permit a greater depth of liquid ponding which increases the

hydraulic gradient across the infiltrative surface. In some instances, deep systems can be used to reach more permeable soil horizons when the proximity of groundwater tables do not preclude their use.

Freezing of shallow absorption systems is not a problem if kept in continuous operation (4)(11). Carefully constructed systems with 6 to 12 in. (15 to 30 cm) of soil cover, which are in continuous operation, will not freeze even in areas where frost penetration may be as great as 5 ft (1.5 m) if the distribution pipe is gravel packed and header pipes insulated where it is necessary for them to pass under driveways or other areas usually cleared of snow.

Alternating Systems: Dividing the soil absorption system into more than one field to allow alternate use of the individual fields over extended periods of time can extend the life of the absorption system. Alternating operation of the fields permits part of the system to "rest" periodically so that the infiltrative surface can be rejuvenated naturally through biodegradation of the clogging mat (4)(11)(12)(13)(15)(16). The "resting" field also acts as a standby unit that can be put into immediate service if a failure occurs in the other part of the system. This provides a period of time during which the failed field can be rehabilitated or rebuilt without an unwanted discharge.

Alternating systems commonly consist of two fields. Each field contains 50 to 100% of the total required area for a single field. Common practice is to switch fields on a semiannual or annual schedule by means of a diversion valve (see Figure 7-3 and Chapter 8). Though it has not yet been proven, such operation may permit a reduction in the total system size. In sandy soils with a shallow water table, the use of alternating beds may increase the chance of groundwater contamination because of the loss of treatment efficiency when the clogging mat is decomposed after resting.

c. Layout of the System

Location: Locating the area for the soil absorption system should be done with care. On undeveloped lots, the site should be located prior to locating the house, well, drives, etc., to ensure the best area is reserved. The following recommendations should be considered when locating the soil absorption system:

1. Locate the system where the surface drainage is good. Avoid depressions and bases of slopes and areas in the path of runoff from roofs, patios, driveways, or other paved areas unless surface drainage is provided.

FIGURE 7-3

ALTERNATING TRENCH SYSTEM WITH DIVERSION VALVE

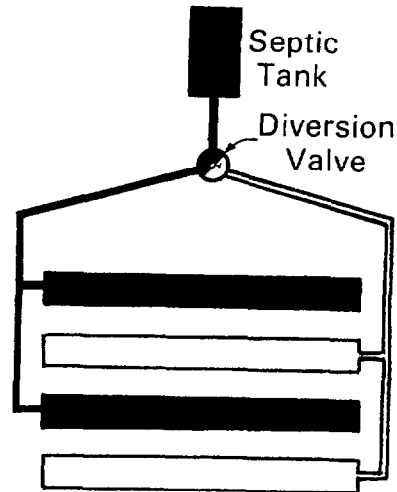

2. In areas with severe winters, avoid areas that are kept clear of snow. Automobiles, snowmobiles, and other vehicles should not be allowed on the area. Compacted or cleared snow will allow frost to penetrate the system, and compacted soil and loss of vegetation from traffic over the system will reduce evapotranspiration in the summer.
3. Preserve as many trees as possible. Trenches may be run between trees. Avoid damaging the trees during construction.

Configuration: Trenches should be used wherever possible. Not only do trenches perform better than beds, but they also conform to the site more easily. Trenches do not need to be straight, but should be curved to fit the contour of the lot or to avoid trees. A multi-trench system is preferable to a single trench because of the flexibility it offers in wastewater application.

On lots with insufficient area for trenches or on sites with granular soils, beds may be used. If only a sloping site exists, the bed should be constructed with long axes following the contour. However, beds should not be constructed on sites with slopes greater than 10% because the excavation becomes too deep on the upslope side. In such instances,

deep trenches with a greater depth of rock below the distribution pipe to increase the sidewall area is more suitable.

Reserve Area: When planning and locating the absorption system, consideration should be given to reserving a suitable area for construction of a second system. The second system would be added if the first were to fail or if the system required expansion due to increased wastewater flows. Care must be used in constructing the second system so that the original system is not damaged by the construction equipment.

The reserve area should be located to facilitate simultaneous or alternating loading of both systems. If the reserve area is used because the initial system has failed, the failing system should not be permanently abandoned. With time, the initial system will be naturally rejuvenated and can be used alternately with the reserve system. Reserve areas can be provided very easily with trench systems by reserving sufficient area between the initial trenches as shown in Figure 7-4.

Dimensions: The absorption system should be dimensioned to best fit the lot while maintaining separation distances and avoiding excessive depths of excavation. Commonly used dimensions are given in Table 7-3.

The depth of excavation is determined by the location of the most permeable soil horizon and flow restricting layers or the high water table elevation. Unless a deep, more permeable horizon exists, the trench or bed bottom elevation should be maintained at about 18 to 24 in. (46 to 61 cm) below the natural ground surface. To prevent freezing in cold climates, 6 to 12 in. (15 to 30 cm) of cover should be backfilled over the aggregate (11).

If the water table or a very slowly permeable layer is too near the ground surface to construct the system at this depth, the system can be raised. Very shallow trenches 6 to 12 in. (15 to 30 cm) deep can be installed and the area backfilled with additional soil (see Figure 7-5). Adequate separation distance must be provided between the trench bottom and the seasonally high groundwater level to prevent groundwater contamination.

The length of the trench or bed system depends on the site characteristics. The length of the distribution laterals is commonly restricted to 100 ft (30 m). This is based on the fears of root penetration, uneven settling, or pipe breakage which could disrupt the flow down the pipe to render the remaining downstream length useless. However, these fears are unwarranted because the aggregate transmits the wastewater (4)(13)(17). To assure adequate transmission and distribution of the

FIGURE 7-4

PROVISION OF A RESERVE AREA BETWEEN TRENCHES
OF THE INITIAL SYSTEM ON A SLOPING SITE

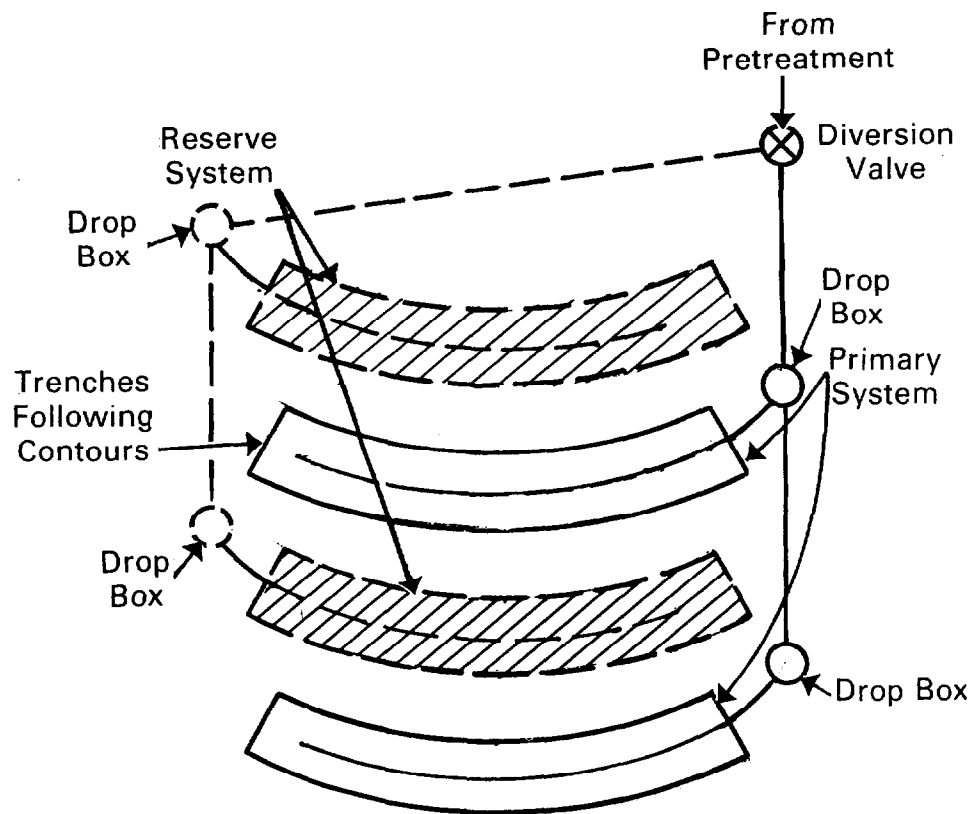

wastewater through the aggregate, extreme care must be taken to construct the trench bottom at the same elevation throughout its length. The overriding considerations for determining trench or bed lengths are the site characteristics.

Spacing between trench sidewalls could be as little as 18 in. (46 cm). A spacing of 6 ft (1.8 m) is suggested, however, to facilitate construction and to provide a reserve area between trenches.

TABLE 7-3
TYPICAL DIMENSIONS FOR TRENCHES AND BEDS

| <u>System</u> | <u>Width</u> ft | <u>Length^b</u> ft | <u>Bottom</u> <u>Depth^c</u> ft | <u>Cover</u> <u>Thickness</u> in. | <u>Spacing^d</u> ft |
|---------------|--------------------|---------------------------------|---|---|----------------------------------|
| Trenches | 1-3 ^a | 100 | 1.5-2.0 | 6 (min) | 6 |
| Beds | >3 | 100 | 1.5-2.0 | 6 (min) | 6 |

^a Excavations generally should not be less than 1 ft wide because the sidewall may slough and infiltrate the aggregate(10)

^b Length of lateral from distribution inlet manifold. May be greater if site characteristics demand.

^c May be deeper if a more suitable horizon exists at greater depth and sufficient depth can be maintained between the bottom and seasonably high water table.

^d From sidewall to sidewall. Trench spacing may be decreased because of soil flow net patterns, specifically for shallow trenches in sandy soils.

FIGURE 7-5

TRENCH SYSTEM INSTALLED TO OVERCOME A SHALLOW WATER TABLE OR RESTRICTIVE LAYER [AFTER (11)]

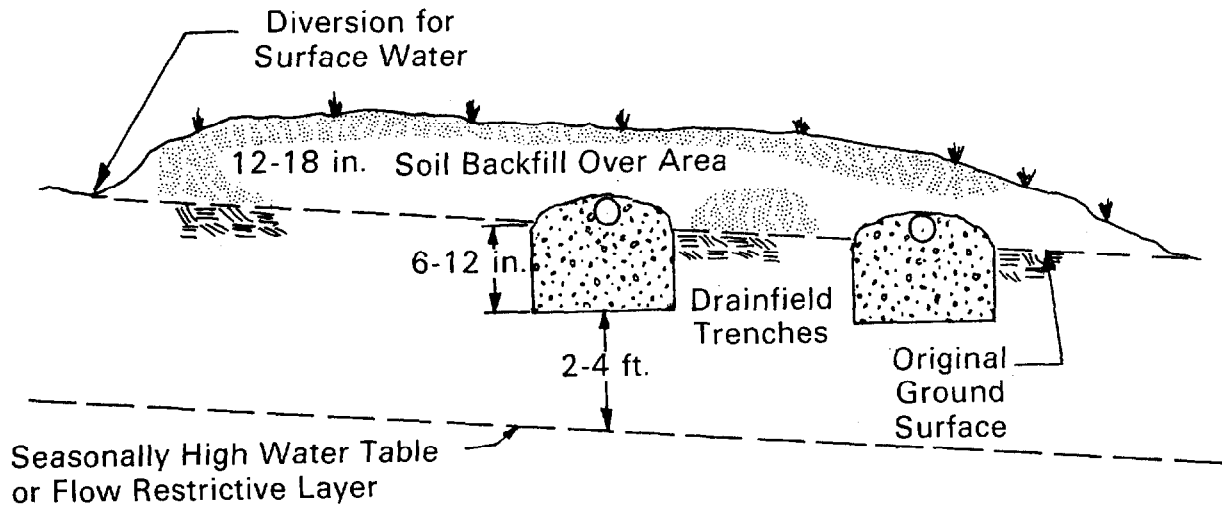

d. Effluent Distribution

Methods of Application: To ensure that the absorption system performs satisfactorily over a reasonably long lifetime, the method of wastewater application to the infiltrative surface must be compatible with the existing soil and site characteristics. Methods of wastewater application can be grouped into three categories: (1) gravity flow; (2) dosing; and (3) uniform application. For designs of distribution networks employing these methods, see Section 7.2.8)

1. Gravity flow is the simplest and most commonly employed of the distribution methods. Wastewater is allowed to flow into the absorption system directly from the treatment unit. With time, a clogging mat usually develops on the bottom surface of the absorption system and continuous ponding of the wastewater results. This may lead to more severe clogging of the soil, reducing the infiltration rate. However, this effect may be offset by the greater effective infiltrative area provided by submerging the sidewalls of the system, particularly in trench systems. The ponding also increases the hydraulic gradient

across the clogging mat, which can increase the infiltration rate (2)(18).

If adequate treatment is to be achieved in coarse granular soils such as sands, wastewater application by gravity flow requires that a clogging mat exist at the infiltrative surfaces to prevent saturated conditions in the underlying soil and to prevent groundwater contamination. The mat develops with continued application, but groundwater contamination by pathogenic organisms and viruses can be a danger at first.

2. Dosing can be employed to provide intermittent aeration of the infiltrative surface. In this method, periods of loading are followed by periods of resting, with cycle frequencies ranging from hours to days. The resting phase should be sufficiently long to allow the system to drain and expose the infiltrative surface to air, which encourages rapid degradation of the clogging materials by aerobic bacteria.

This method of operation may increase the rate of infiltration, as well as extend the life of the absorption system, because the clogging mat resistance is reduced (1)(4)(6)(15)(17). In sands or coarser textured materials, the rapid infiltration rates can lead to bacterial and viral contamination of shallow groundwater, especially when first put into use (4). Therefore, systems constructed in these soils should be dosed with small volumes of wastewater several times a day to prevent large saturated fronts moving through the soil. In finer textured soils, absorption, rather than treatment, is the concern. Large, less frequent doses are more suitable in these soils to provide longer aeration times between doses (4). See Table 7-4 for suggested dosing frequencies.

3. Uniform Application means applying the wastewater in doses uniformly over the entire bottom area of the system to minimize local overloading and the depth of ponding following each dose. This is usually achieved with a pressure distribution network. In this manner, the soil is more likely to remain unsaturated even during initial start-up when no clogging mat is present. The minimum depths of ponding during application permit rapid draining and maximum exposure of the bottom surface to air which reduces the clogging mat resistance. The sidewall is lost as an infiltrative surface, but this may be compensated for by the maintenance of higher infiltration rates through the bottom surface. See Table 7-4 for suggested dosing frequencies.

TABLE 7-4
DOSING FREQUENCIES FOR VARIOUS SOIL TEXTURES

| <u>Soil Texture</u> | <u>Dosing Frequency</u> |
|------------------------------|-------------------------------------|
| Sand | 4 Doses/Day |
| Sandy Loam | 1 Dose/Day |
| Loam | Frequency Not Critical ^a |
| Silt Loam Silty Clay Loam | 1 Dose/Day ^a |
| Clay | Frequency Not Critical ^a |

^a Long-term resting provided by alternating fields may be desirable.

Selection of Application Method: The selection of an appropriate method of wastewater application depends on whether improved absorption or improved treatment is the objective. This is determined by the soil permeability and the geometry of the infiltrative surface. Under some conditions, the method of application is not critical, so selection is based on simplicity of design, operation, and cost. Methods of application for various soil and site conditions are summarized in Table 7-5. Where more than one may be appropriate, the methods are listed in order of preference.

e. Porous Media

The function of the porous media placed below and around the distribution pipe is four-fold. Its primary purposes are to support the distribution pipe and to provide a media through which the wastewater can flow from the distribution pipe to reach the bottom and sidewall infiltration areas. A second function is to provide storage of peak wastewater flows. Third, the media dissipates any energy that the incoming wastewater may have which could erode the infiltrative surface. Finally, the media supports the sidewall of the excavation to prevent its collapse.

TABLE 7-5
METHODS OF WASTEWATER APPLICATION FOR VARIOUS SYSTEM DESIGNS
AND SOIL PERMEABILITIES^a

| <u>Soil Permeability (Percolation Rate)</u> | <u>Trenches or Beds (Fills, Drains) On Level Site</u> | <u>Trenches (Drains) On Sloping Site (>5%)</u> |
|---|---|---|
| Very Rapid (<1 min/in.) | Uniform Application ^b Dosing | Gravity Dosing |
| Rapid (1-10 min/in.) | Uniform Application Dosing Gravity | Gravity Dosing |
| Moderate (11-60 min/in.) | Dosing Gravity Uniform Application | Gravity Dosing |
| Slow (>60 min/in.) | Not Critical | Not Critical |

^a Methods of application are listed in order of preference.

^b Should be used in alternating field systems to ensure adequate treatment.

The depth of the porous media may vary. A minimum of 6 in. (15 cm) below the distribution pipe invert and 2 in. (5 cm) above the crown of the pipe is suggested. Greater depths may be used to increase the sidewall area and to increase the hydraulic head on the infiltrative surface.

Gravel or crushed rock is usually used as the porous media, though other durable porous materials may be suitable. The suggested gravel or rock size is 3/4 to 2-1/2 in. (1.8 to 6.4 cm) in diameter. Smaller sizes are preferred because masking of the infiltrative surface by the rock is reduced (13). The rock should be durable and resistant to slaking and dissolution. A hardness of 3 or greater on the Moh's Scale of Hardness is suggested. Rock that can scratch a copper penny without leaving any residual rock meets this criterion. Crushed limestone is unsuitable unless dolomitic. The media should be washed to remove all fines that could clog the infiltrative surface.

To maintain the porous nature of the media, the media must be covered with a material to prevent backfilled soil from entering the media and filling the voids. Treated building paper was once used but has been abandoned in favor of untreated building paper, synthetic drainage fabric, marsh hay or straw. These materials do not create a vapor barrier and permit some moisture to pass through to the soil above where it can be removed through evapotranspiration. All these materials, except for the drainage fabric, will eventually decay. If they decay before the soil has stabilized, the value of the materials is lost. To ensure the barrier is not lost prematurely, heavy duty building paper of 40 to 60 lb (18 to 27 kg) weight or a 4 to 6 in. (10 to 15 cm) layer of marsh hay or straw should be used. In dry sandy soils, a 4 in. (10 cm) layer of hay or straw covered with untreated building paper is suggested to prevent the backfill from filtering down into the rock.

f. Inspection Pipes

Inspection pipes located in the subsurface soil absorption system provide limited access to observe the depth of ponding, a measure of the performance of the system, and a means of locating the subsurface field. If used, the inspection pipes should extend from the bottom infiltrative surface of the system up to or above final grade. The bottom should be open and the top capped. The portion of the pipe within the gravel should be perforated to permit a free flow of water (see Figure 7-6).

7.2.2.4 Construction

A frequent cause of early failure of soil absorption systems is the use of poor construction techniques. The following should be considered for construction of a soil absorption system:

a. Layout

The system should be laid out to facilitate the maneuvering of construction equipment so that damage to the soil is minimized.

1. Absorption system area should be staked out and roped off immediately after the site evaluation to keep construction equipment and other vehicles off the area until construction of the system begins.
2. Trenches rather than beds are preferable in soils with significant clay content (greater than 25% by weight) because equipment can straddle the trenches. This reduces the compaction and smearing at the exposed infiltrative surface.
3. Trenches should be spaced at least 6 ft (1.8 m) apart to facilitate the operation of the construction equipment if there is sufficient area.
4. To minimize sidewall compaction, trench widths should be made larger than the bucket used for excavation. Buckets are made to compact the sidewall to prevent caving during excavation. If the excavation is wider than the bucket, this effect is minimized. An alternative is to use modified buckets with side cutters or raker teeth (see Figure 7-7).
5. Trenches should follow the contour and be placed outside the drip lines of trees to avoid root damage.

b. Excavation

Absorption of waste effluent by soil requires that the soil pores remain open at the infiltrative surface. If these are sealed during construction by compaction, smearing, or puddling of the soil, the system may be rendered useless. The tendency toward compaction, smearing, and puddling depends upon the soil type, moisture content, and applied force.

FIGURE 7-6
TYPICAL INSPECTION PIPE

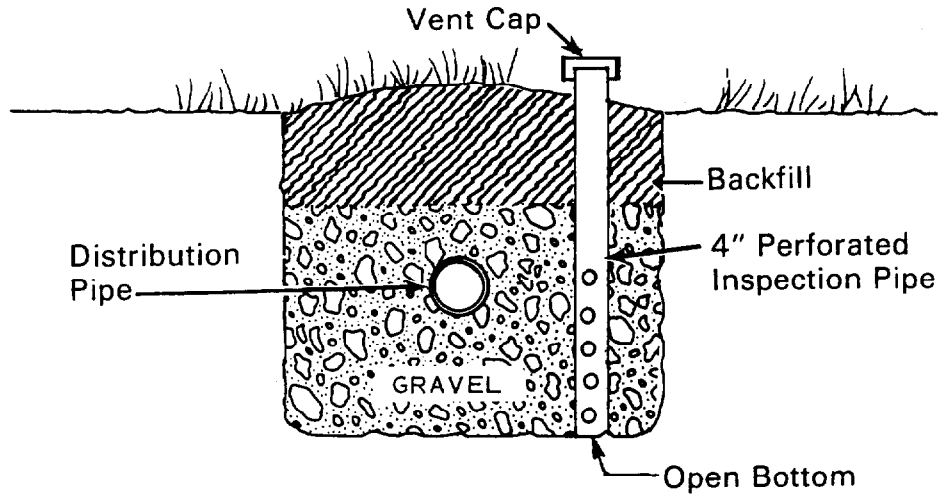
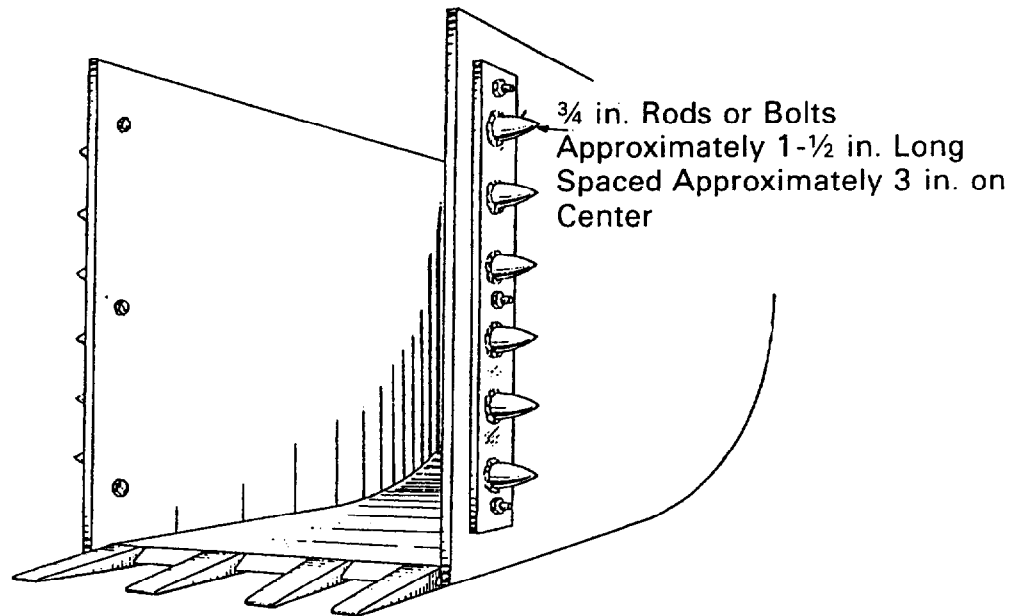

FIGURE 7-7
BACKHOE BUCKET WITH REMOVABLE RAKER TEETH (11)



Soils with high clay contents (greater than 25% by weight) are very susceptible to damage, while sands are rarely affected. Careful construction techniques minimize this soil damage. They include:

1. Excavation may proceed in clayey soils only when the moisture content is below the soil's plastic limit. If a sample of soil taken at the depth of the proposed bottom of the system forms a "wire" instead of crumbling when attempting to roll it between the hands, the soil is too wet.
2. A backhoe is usually used to excavate the system. Front-end loaders or bulldozer blades should not be used because the scraping action of the bucket or blade can smear the soil severely, and the wheels or tracks compact the exposed infiltrative surface.
3. Excavation equipment must not be driven on the bottom of the system. If trenches are used, the equipment can straddle the excavation. If a bed is used, the bed should be divided into segments so the machinery can always operate from undisturbed soil.
4. The bottom of each trench or bed must be level throughout to ensure more uniform distribution of effluent. A level and tripod are essential equipment.
5. The bottom and sidewalls of the excavation should be left with a rough open surface. Any smeared and compacted surfaces should be removed with care.
6. Work should be scheduled only when the infiltrative surface can be covered in one day, because wind-blown silt or raindrop impact can clog the soil.

c. Backfilling

Once the infiltrative surface is properly prepared, the backfilling operations must be done carefully to avoid any damage to the soil.

1. The gravel or crushed rock used as the porous media is laid in by a backhoe or front-end loader rather than dumped in by truck. This should be done from the sides of the system rather than driving out onto the exposed bottom. In large beds, the gravel or rock should be pushed out ahead of a small bulldozer.
2. The distribution pipes are covered with a minimum of 2 in. (5 cm) of gravel or rock to retard root growth, to insulate

against freezing and to stabilize the pipe before backfilling. Procedures for constructing the distribution network are discussed in Section 7.2.8.

3. The gravel or rock is covered with untreated building paper, synthetic drainage fabric, marsh hay or straw to prevent the unconsolidated soil cover from entering the media. The media should be covered completely. If untreated building paper is used, the seams should overlap at least 2 in. (5 cm) and any tears covered. If marsh hay or straw is used, it should be spread uniformly to a depth of 4 to 6 in. (10 to 15 cm). In bed construction, spreading a layer of hay or straw covered with untreated building paper is good practice.
4. The backfill material should be similar to the natural soil and no more permeable. It should be mounded above natural grade to allow for settling and to channel runoff away from the system.

7.2.2.5 Operation and Maintenance

a. Routine Maintenance

Once installed, a subsurface soil absorption system requires little or no attention as long as the wastewater discharged into it is nearly free of settleable solids, greases, fats, and oils. This requires that the pretreatment unit be maintained (see Chapter 6). To provide added insurance that the system will have a long, useful life, the following actions are suggested:

1. Resting of the system by taking it out of service for a period of time is an effective method of restoring the infiltration rate. Resting allows the absorption field to gradually drain, exposing the infiltrative surfaces to air. After several months, the clogging mat is degraded through biochemical and physical processes (1)(4)(6)(13)(15). This requires that a second absorption system exist to allow continued disposal, while the first is in the resting phase. The systems can be alternated on a yearly basis by means of a diversion valve (see Figure 7-3).
2. The plumbing fixtures in the home should be checked regularly to repair any leaks which can add substantial amounts of water to the system.
3. The use of special additives such as yeast, bacteria, chemicals, and enzyme preparations is not necessary and is of

little value for the proper function of the soil absorption system (3)(4).

4. Periodic application of oxidizing agents, particularly hydrogen peroxide, are being tried as a preventative maintenance procedure (19). If properly applied, the agents oxidize the clogging mat to restore much of the system's infiltration capacity within a day or two. Handling of these agents is very dangerous, and therefore the treatment should be done by trained individuals only. Experience with this treatment has been insufficient to determine its long-term effectiveness in a variety of soil types.

b. Rehabilitation

Occasionally, soil absorption systems fail, necessitating their rehabilitation. The causes of failure can be complex, resulting from poor siting, poor design, poor construction, poor maintenance, hydraulic overloading, or a combination of these. To determine the most appropriate method of rehabilitation, the cause of failure must be determined. Figure 7-8 suggests ways to determine the cause of failure and corresponding ways of rehabilitating the system.

The failure frequency should be determined before isolating the cause. Failure may occur occasionally or continuously. Occasional failure manifests itself with occasional seepage on the ground surface, sluggish drains, or plumbing backups. These usually coincide with periods of heavy rainfall or snowmelt. Continuous failure can have the same symptoms but on a continuous basis. However, some systems may seriously contaminate the groundwater with no surface manifestations of failure. These failures are detected by groundwater sampling.

Occasional Failure: The cause of occasional failure is much easier to determine, and rehabilitation can be more simple. Since the system functions between periods of failure, sizing and construction usually can be eliminated as the cause. In these instances, failure is the result of poor siting, poor maintenance, or hydraulic overloading. Excessive water use, plumbing leaks, or foundation drain discharges are common reasons for hydraulic overloading. These can be corrected by the appropriate action as indicated in Figure 7-8.

The next step is to investigate the site of the absorption system. Occasional failure usually is due to poor drainage or seasonally high water table conditions. The surface grading and landscape position should be checked for poor surface drainage conditions. Local soil conditions should also be investigated by borings for seasonally high

FIGURE 7-8

METHODS OF SOIL ABSORPTION FIELD REHABILITATION

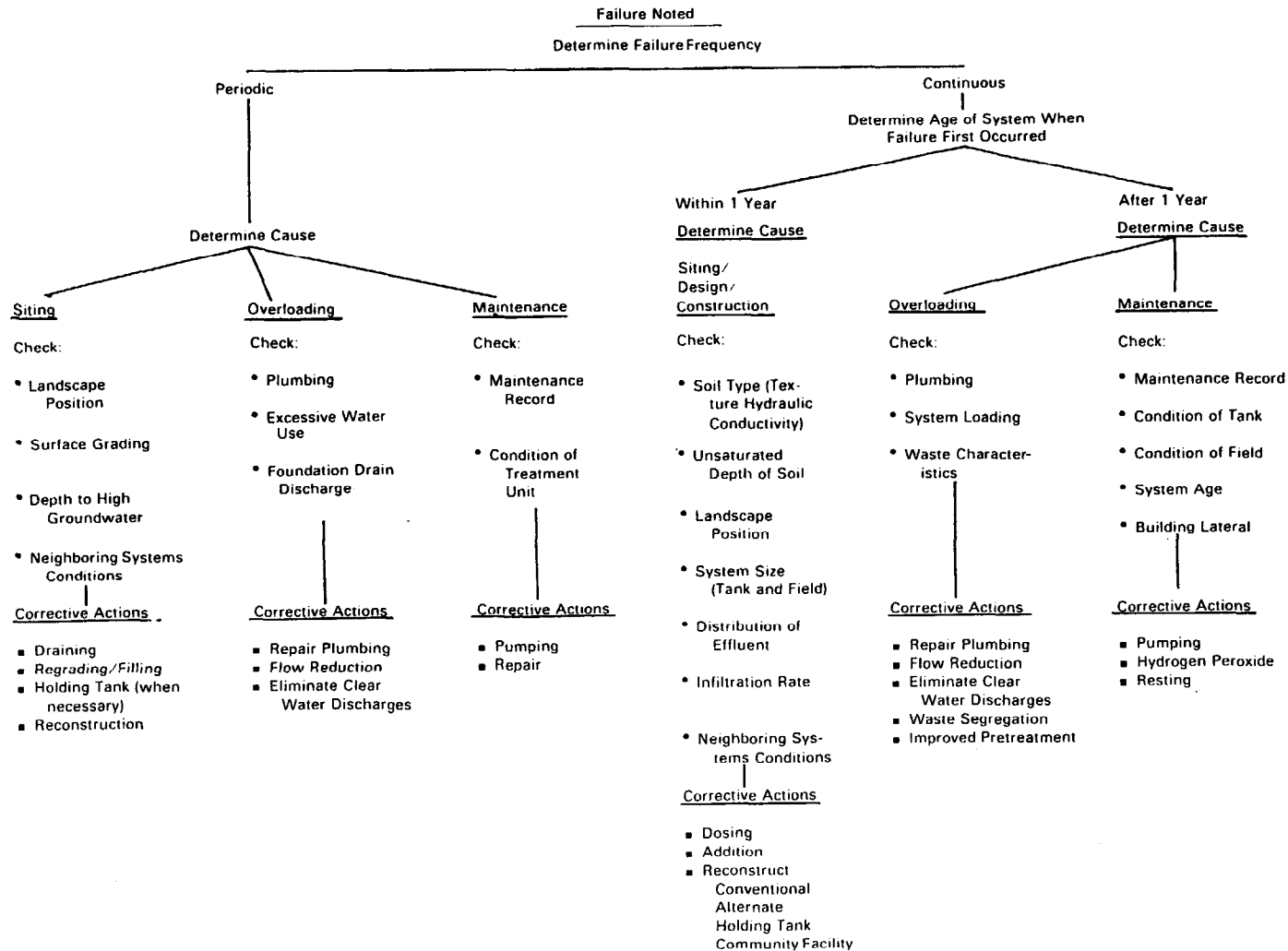

water tables (see Chapter 3). Corrective actions include improving surface drainage by regrading or filling low areas. High water table conditions may be corrected in some instances by installing drains (see Section 7.2.6).

Lack of maintenance of the treatment unit preceding the soil absorption field may also be a cause of occasional failure. The unit may be a point of infiltration and inflow during wet periods. The unit should be pumped and leaks repaired.

Continuous Failure: The causes of continuous failure are more difficult to determine. However, learning the age of the system when failure first occurred is very useful in isolating the cause.

If failure occurred within the first year of operation, the cause is probably due to poor siting, design, or construction. It is useful to check the performance of neighboring systems installed in similar soils. If they have similar loading rates and are working well, the failing system should be checked for proper sizing. A small system can be enlarged by adding new infiltration areas. In some instances, the sizing may be adequate but the distribution of the wastewater is poor due to improper construction. Providing dosing may correct this problem (see Section 7.2.8). Damage to the soil during construction may also cause failure, in which case the infiltrative area is less effective. Reconstruction or an addition is necessary. Alternate systems should be considered if the site is poor. This includes investigating the feasibility of a cluster or community system if surrounding systems are experiencing similar problems.

If the system had many years of useful service before failure occurred, hydraulic overloading or poor maintenance is usually the cause. The first step is to find out as much about the system as possible. A sketch of the system showing the size, configuration, and location should be made. A soil profile description should also be obtained. These items may be on file at the local regulatory agency but their accuracy should be confirmed by an onsite visit. If the system provided several years of useful service, evidences of overloading should be investigated first. Wastewater volume and characteristics (solids, greases, fats, oil) should be determined. Overloading may be corrected by repairing plumbing, installing flow reduction fixtures (see Chapter 5), and eliminating any discharges from foundation drains. If the volume reductions are insufficient for acceptance by the existing infiltrative surface, then additional infiltrative areas must be constructed. Systems serving commercial buildings may fail because of the wastewater characteristics. High solids concentrations or large amounts of fats,

oils, and greases, can cause failure. This is particularly true of systems serving restaurants and laundromats. These failures can be corrected by segregating the wastewaters to eliminate the troublesome wastewaters (see Chapter 5), or by improving pretreatment (see Chapter 6).

Lack of proper maintenance of the treatment unit may have resulted in excessive clogging due to poor solids removal by the unit. This can be determined by checking the maintenance record and the condition of the unit. If this appears to be the problem, the unit should be pumped and repaired, or replaced if necessary. The infiltrative surface of the absorption field should also be checked. If siting, design, or maintenance do not appear to be the cause of failure, excessive clogging is probably the problem. In such cases, the infiltrative surface can sometimes be rejuvenated by oxidizing the clogging mat (4)(9)(13)(16). This can be done by allowing the system to drain and rest for several months (4). To permit resting, a new system must be constructed with means provided for switching back and forth. Alternatively, the septic tank could be operated as a holding tank until the clogging mat has been oxidized. However, this involves frequent pumping, which may be costly. Another method, still in the experimental stage, is the use of the chemical oxidant, hydrogen peroxide (16). Because it is new, it is not known if it will work well in all soils. Extreme care should be used in its application because it is a strong oxidizing agent. Only individuals trained in its use should perform the treatment.

7.2.2.6 Considerations for Multi-Home and Commercial Wastewaters

Design of trench and bed soil absorption systems for small institutions, commercial establishments, and clusters of dwellings generally follows the same design principles as for single dwellings. In cluster systems serving more than about five homes, however, peak flow estimates can be reduced because of flow attenuation, but contributions from infiltration through the collection system must be included. Peak flow estimates should be based on the total number of people to be served (see Chapter 4). Rates of infiltration will vary with the type of collection sewer used (19)(20).

With commercial flows, the character of the wastewater is an important consideration. Proper pretreatment is necessary if the character is significantly different than domestic wastewater.

Flexibility in operation should also be incorporated into systems serving larger flows since a failure can create a significant problem. Alternating bed systems should be considered. A three-field system can be constructed in which each field contains 50% of the required absorption

area (19). This design allows flexibility in operation. Two beds are always in operation, providing 100% of the needed infiltrative surface. The third field is alternated in service on a semi annual or annual schedule. Thus, each field is in service for one or two years and "rested" for 6 months to one year to rejuvenate. The third field also acts as a standby unit in case one field fails. The idle field can be put into service immediately while a failed field is rehabilitated. Larger systems should utilize some dosing or uniform application to assure proper performance.

7.2.3 Seepage Pits

7.2.3.1 Description

Seepage pits or dry wells are deep excavations used for subsurface disposal of pretreated wastewater. Covered porous-walled chambers are placed in the excavation and surrounded by gravel or crushed rock (see Figure 7-9). Wastewater enters the chamber where it is stored until it seeps out through the chamber wall and infiltrates the sidewall of the excavation.

Seepage pits are generally discouraged by many local regulatory agencies in favor of trench or bed systems. However, seepage pits have been shown to be an acceptable method of disposal for small wastewater flows (21). Seepage pits are used where land area is too limited for trench or bed systems; and either the groundwater level is deep at all times, or the upper 3 to 4 ft (0.9 to 1.2 m) of the soil profile is underlain by a more permeable unsaturated soil material of great depth.

7.2.3.2 Site Considerations

The suggested site criteria for seepage pits are similar to those for trench and bed systems summarized in Table 7-1 except that soils with percolation rates slower than 30 min/in. (12 min/cm) are generally excluded. In addition, since the excavation sidewall is used as the infiltrative surface, percolation tests are run in each soil layer encountered. Maintaining sufficient separation between the bottom of the seepage pit and the high water table is a particularly important consideration for protection of groundwater quality.

FIGURE 7-9
SEEPAGE PIT CROSS SECTION

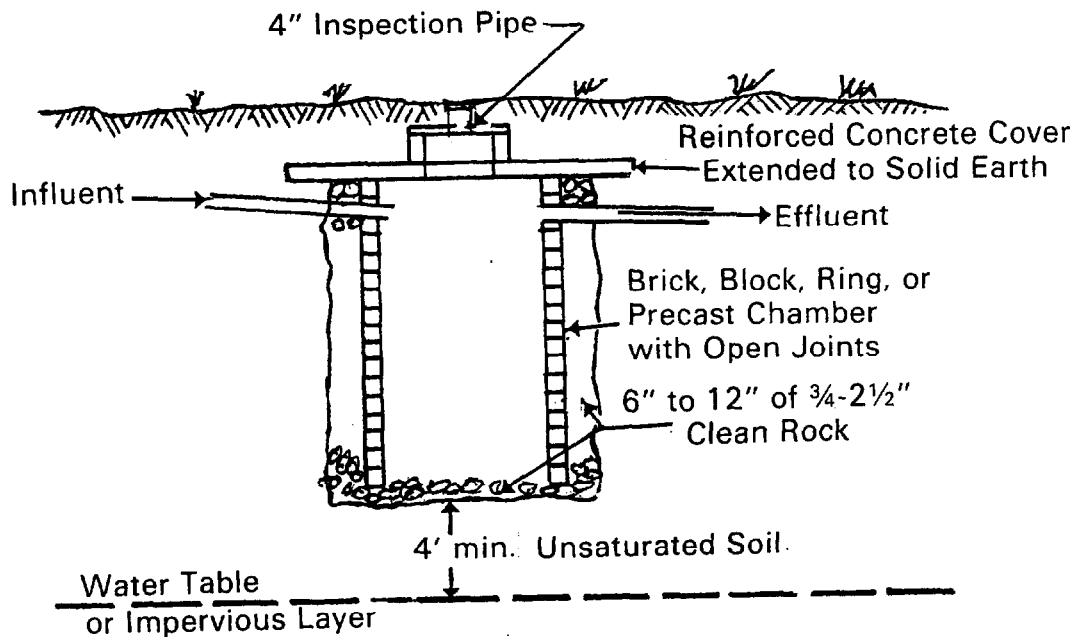

7.2.3.3 Design

a. Sizing the Infiltrative Surface

Since the dominant infiltration surface of a seepage pit is the sidewall, the depth and diameter of the pit is determined from the percolation rate and thickness of each soil layer exposed by the excavation. A weighted average of the percolation test results (sum of thickness times percolation rate of each layer divided by the total thickness) is used. Soil layers with percolation rates slower than 30 min/in. (12 min/cm) are excluded from this computation (3).

The weighted percolation rate is used to determine the required sidewall area. Infiltration rates presented previously in Table 7-2 are used with the estimated daily wastewater flow to compute the necessary sidewall area.

Table 7-6 can be used to determine the necessary seepage pit sidewall area for various effective depths below the seepage pit inlet.

TABLE 7-6
SIDEWALL AREAS OF CIRCULAR SEEPAGE PITS (ft²)^a

| Seepage ^b Pit Diameter ft | Thickness of Effective Layers Below Inlet (ft) | | | | | | | | | |
|---|--|----|-----|-----|-----|-----|-----|-----|-----|-----|
| | 1 | 2 | 3 | 4 | 5 | 6 | 7 | 8 | 9 | 10 |
| 1 | 3.1 | 6 | 9 | 13 | 16 | 19 | 22 | 25 | 28 | 31 |
| 2 | 6.3 | 13 | 19 | 25 | 31 | 38 | 44 | 50 | 57 | 63 |
| 3 | 9.4 | 19 | 28 | 38 | 47 | 57 | 66 | 75 | 85 | 94 |
| 4 | 12.6 | 25 | 38 | 50 | 63 | 75 | 88 | 101 | 113 | 126 |
| 5 | 15.7 | 31 | 47 | 63 | 79 | 94 | 110 | 126 | 141 | 157 |
| 6 | 18.8 | 38 | 57 | 75 | 94 | 113 | 132 | 151 | 170 | 188 |
| 7 | 22.0 | 44 | 66 | 88 | 110 | 132 | 154 | 176 | 198 | 220 |
| 8 | 25.1 | 50 | 75 | 101 | 126 | 151 | 176 | 201 | 226 | 251 |
| 9 | 28.3 | 57 | 85 | 113 | 141 | 170 | 198 | 226 | 254 | 283 |
| 10 | 31.4 | 63 | 94 | 126 | 157 | 188 | 220 | 251 | 283 | 314 |
| 11 | 34.6 | 69 | 104 | 138 | 173 | 207 | 242 | 276 | 311 | 346 |
| 12 | 37.7 | 75 | 113 | 151 | 188 | 226 | 264 | 302 | 339 | 377 |

^a Areas for greater depths can be found by adding columns. For example, the area of a 5 ft diameter pit, 15 ft deep is equal to 157 + 79, or 236 ft.

^b Diameter of excavation.

b. System Layout

Seepage pits may be any diameter or depth provided they are structurally sound and can be constructed without seriously damaging the soil. Typically, seepage pits are 6 to 12 ft (1.8 to 3.6 m) in diameter and 10 to 20 ft (3 to 6 m) deep but pits 18 in. (0.5 m) in diameter and 40 ft (12 m) deep have been constructed (22). When more than one pit is required, experience has shown that a separation distance from sidewall to sidewall equal to 3 times the diameter of the largest pit should be maintained (3).

The same guidelines used in locating trenches and beds are used to locate seepage pits. Area should be reserved for additional pits if necessary.

7.2.3.4 Construction

Pits may be dug with conventional excavating equipment or with power augers. Particular care must be exercised to ensure that the soils are not too wet before starting construction. If powered bucket augers are used, the pits should be reamed to a larger diameter than the bucket to minimize compaction and smearing of the soil. Power screw augers should only be used in granular soils because smearing of the sidewall is difficult to prevent with such equipment.

To maximize wastewater storage, porous walled chambers without bottoms are usually used. Precast concrete seepage chambers may be used or the chambers may be constructed out of clay or concrete brick, block or rings. The rings must have notches in them to provide for seepage. Brick or block are laid without mortar, with staggered open joints. Hollow block may be laid on its side but a 4-in. (10-cm) wall thickness should be maintained. Large-diameter perforated pipe standing on end can be used in small diameter pits. Six to 12 in. (15 to 30 cm) of clean gravel or 3/4 to 2-1/2 in. (1.8 to 6.4 cm) crushed rock is placed at the bottom of the excavation prior to placement or construction of the chamber. This provides a firm foundation for the chamber and prevents bottom soil from being removed if the pit is pumped.

The chamber is constructed one to two feet smaller in diameter than the excavation. The annular space left between the wall of the chamber and the excavation is filled with clean gravel or crushed rock to the top of the chamber.

Covers of suitable strength to support the soil cover and any anticipated loads are placed over the chamber and extend at least 12 in. beyond the excavation. Access to the pit for inspection purposes can be provided by a manhole. If a manhole is used, it should be covered with 6 to 12 in. (15 to 30 cm) of soil. An inspection pipe can extend to ground surface. A noncorrosive, watertight cap should be used with the inspection pipe.

7.2.3.5 Maintenance

A well-designed and constructed seepage pit requires no routine maintenance. However, failure occasionally occurs. Pumping and resting is the only reasonable rehabilitation technique available.

7.2.4 Mound Systems

7.2.4.1 Description

The mound system was originally developed in North Dakota in the late 1940's where it became known as the NODAK disposal system (23). The mound was designed to overcome problems with slowly permeable soils and high water tables in rural areas. The absorption bed was constructed in coarse gravel placed over the original soil after the topsoil was removed. Monitoring of these systems revealed that inadequate treatment occurred before the groundwater was reached, and seepage often occurred during wet periods of the year. Successful modifications of the design were made to overcome these limitations (4). Mound systems are now used under a variety of conditions.

A mound system is a soil absorption system that is elevated above the natural soil surface in a suitable fill material. The purpose of the design is to overcome site restrictions that prohibit the use of conventional soil absorption systems (4)(24). Such restrictions are: (1) slowly permeable soils, (2) shallow permeable soils over creviced or porous bedrock, and (3) permeable soils with high water tables. In slowly permeable soils, the mound serves to improve absorption of the effluent by utilizing the more permeable topsoil and eliminating construction in the wetter and more slowly permeable subsoil, where smearing and compaction are often unavoidable. In permeable soils with insufficient depth to groundwater or creviced or porous bedrock, the fill material in the mound provides the necessary treatment of the wastewater (see Figure 7-10).

The mound system consists of: (1) a suitable fill material, (2) an absorption area, (3) a distribution network, (4) a cap, and (5) top soil (see Figure 7-11). The effluent is pumped or siphoned into the absorption area through a distribution network located in the upper part of the coarse aggregate. It passes through the aggregate and infiltrates the fill material. Treatment of the wastewater occurs as it passes through the fill material and the unsaturated zone of the natural soil. The cap, usually a finer textured material than the fill, provides frost protection, sheds precipitation, and retains moisture for a good vegetative cover. The topsoil provides a growth medium for the vegetation.

FIGURE 7-10
TYPICAL MOUND SYSTEMS

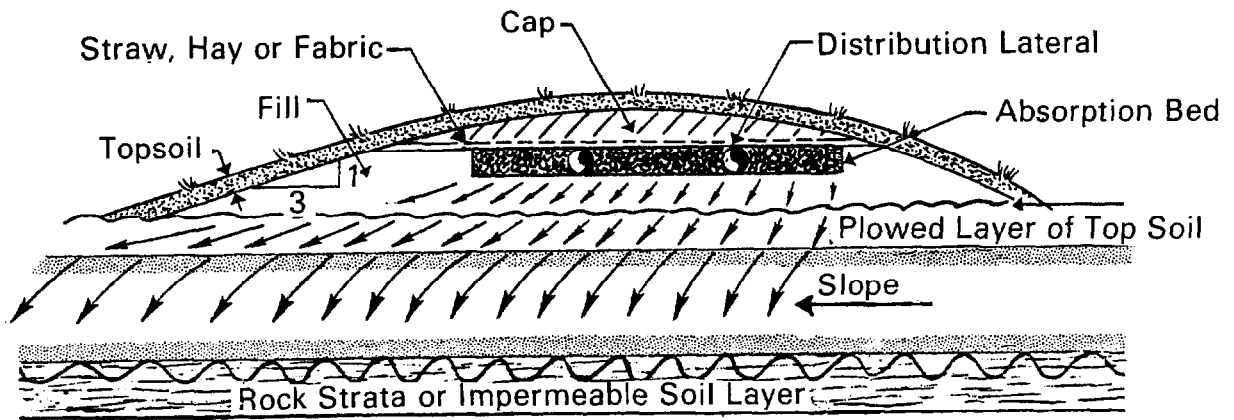

(a) Cross Section of a Mound System for Slowly Permeable Soil on a Sloping Site.

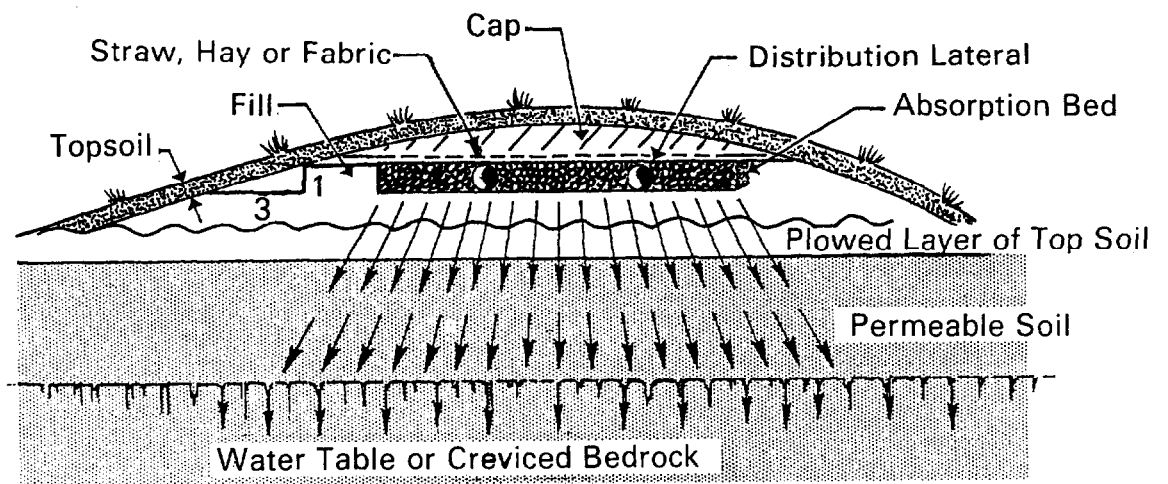

(b) Cross Section of a Mound System for a Permeable Soil, with High Groundwater or Shallow Creviced Bedrock

FIGURE 7-11

DETAILED SCHEMATIC OF A MOUND SYSTEM

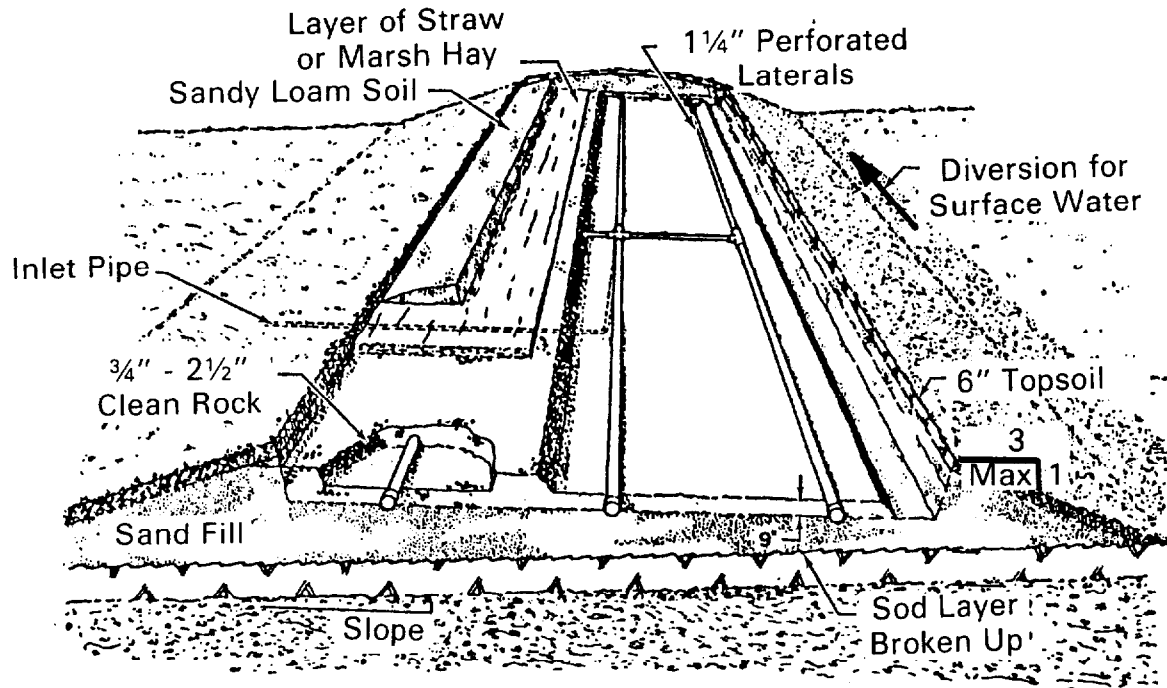

7.2.4.2 Application

a. Site Considerations

Site criteria for mound systems are summarized in Table 7-7. These criteria reflect current practice. Slope limitations for mounds are more restrictive than for conventional systems, particularly for mounds used on sites with slowly permeable soils. The fill material and natural soil interface can represent an abrupt textural change that restricts downward percolation, increasing the chance for surface seepage from the base of the mound.

TABLE 7-7
SITE CRITERIA FOR MOUND SYTSTEMS

| <u>Item</u> | <u>Criteria</u> |
|--|---|
| Landscape Position | Well drained areas, level or sloping. Crests of slopes or convex slopes most desirable. Avoid depressions, bases of slopes and concave slopes unless suitable drainage is provided. |
| Slope | 0 to 6% for soils with percolation rates slower than 60 min/in. ^a 0 to 12% for soils with percolation rates faster than 60 min/in. ^a |
| Typical Horizontal Separation Distances from Edge of Basal Area | |
| Water Supply Wells | 50 to 100 ft |
| Surface Waters, Springs | 50 to 100 ft |
| Escarpments | 10 to 20 ft |
| Boundary of Property | 5 to 10 ft |
| Building Foundations | 10 to 20 ft |
| | (30 ft when located upslope from a building in slowly permeable soils). |
| Soil | |
| Profile Description | Soils with a well developed and relatively undisturbed A horizon (topsoil) are preferable. Old filled areas should be carefully investigated for abrupt textural changes that would affect water movement. Newly filled areas should be avoided until proper settlement occurs. |
| Unsaturated Depth | 20 to 24 in. of unsaturated soil should exist between the original soil surface and seasonally saturated horizons or pervious or creviced bedrock. |

TABLE 7-7 (continued)

| | |
|------------------------------|--|
| Depth to Impermeable Barrier | 3 to 5 ft ^b |
| Percolation Rate | 0 to 120 min/in. measured at 12 to 20 in. ^c |

^a These are present limits used in Wisconsin established to coincide with slope classes used by the Soil Conservation Service in soil mapping. Mounds have been sited on slopes greater than these, but experience is limited (25).

^b Acceptable depth is site dependent.

^c Tests are run at 20 in. unless water table is at 20 in., in which case test is run at 16 in. In shallow soils over pervious or creviced bedrock, tests are run at 12 in.

The acceptable depth to an impermeable layer or rock strata is site specific. Sufficient depth must be available to channel the percolating wastewater away from the mound (see Figure 7-10). If not, the soil beneath the mound and the fill material may become saturated, resulting in seepage of effluent on the ground surface. The suggested depths to an impermeable layer given in Table 7-7 may be adjusted in accordance with the site characteristics. Soil permeability, climate, slope, and mound layout determine the necessary depth. Slowly permeable soils require a greater depth to remove the liquid than do permeable soils. Frost penetration reduces the effective depth and therefore a greater depth is required in areas with severe winters. Level sites require a greater depth because the hydraulic gradients in the lateral direction are less than on sloping sites. Finally, mound systems extended along the contour of a sloping site require less depth than a square mound. Not enough research information is available to give specific depths for these various conditions. Until further information is available, mounds on slowly permeable soils should be made as long as possible, with the restricting layer at least 3 ft (0.9 m) below the natural soil.

b. Influent Wastewater Characteristics

The wastewater entering the mound system should be nearly free from settleable solids, greases, and fats. Septic tanks are commonly used for pretreatment and have proved to be satisfactory. Water softener wastes are not harmful to the system nor is the use of common household chemicals and detergents (9)(10).

7.2.4.3 Design

a. Fill Selection

The mound design must begin with the selection of a suitable fill material because its infiltrative capacity determines the required absorption bed area. Medium texture sands, sandy loams, soil mixtures, bottom ash, strip mine spoil and slags are used or are being tested (24). To keep costs of construction to a minimum, the fill should be selected from locally available materials. Very permeable materials should be avoided, however, because their treatment capacity is less and there is a greater risk of surface seepage from the base of the mound when used over the more slowly permeable soils. Commonly used fill materials and their respective design infiltration rates are presented in Table 7-8.

TABLE 7-8
COMMONLY USED FILL MATERIALS AND THEIR
DESIGN INFILTRATION RATES (24)

| <u>Fill Material</u> | <u>Characteristics^a</u> | | <u>Design Infiltration Rate</u> gpd/ft ² |
|----------------------------|------------------------------------|---------------------------|--|
| Medium Sand | >25% | 0.25-2.0 mm | 1.2 |
| | <30-35% | 0.05-0.25 mm | |
| | <5-10% | 0.002-0.05 mm | |
| Sandy Loam | 5-15% | Clay Content | 0.6 |
| Sand/Sandy Loam Mixture | 88-93% | Sand | 1.2 |
| | 7-12% | Finer Grained Material | |
| Bottom Ash | - | - | 1.2 |

^a Percent by weight.

b. Geometry of the Absorption Bed

The absorption area within the mound system can either be a bed or a series of trenches. Beds are typically used for single homes or other small systems because they are easier to construct. The shape of the bed, however, depends on the permeability of the natural soil and the slope of the site. In most instances, a rectangular bed with the long axis parallel to the slope contour is preferred to minimize the risk of seepage from the base of the mound. If the natural soil has a percolation rate slower than 60 min/in. (24 min/cm), the bed should be made narrow and extended along the contour as far as possible (see Figure 7-12). In soils with percolation rates faster than 60 min/in. (24 min/cm), the bed can be square if the water table is greater than 3 ft (0.9 m) below the natural ground surface (4)(25).

FIGURE 7-12

PROPER ORIENTATION OF A MOUND SYSTEM ON A COMPLEX SLOPE

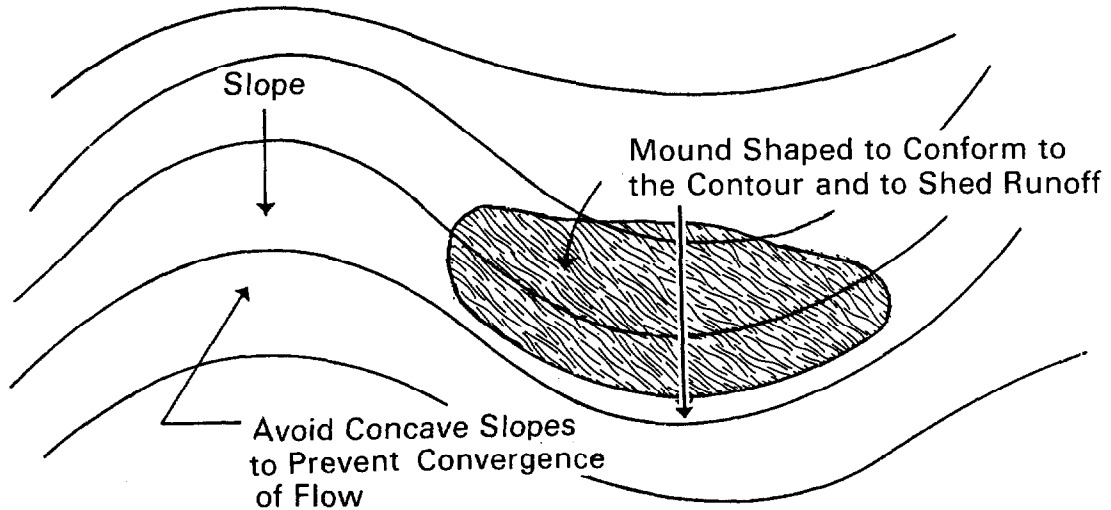

c. Sizing the Filled Area

The dimensions of the mound are dependent on the size and shape of the absorption bed, the permeability of the natural soil, the slope of the site, and the depth of fill below the bed (see Figure 7-13). Depths and dimensions are presented in Table 7-9.

The downslope setback (I) in Figure 7-13 is dependent on the permeability of the natural soil. The basal area of the mound must be sufficiently large to absorb the wastewater before it reaches the perimeter of the mound or surface seepage will result. On level sites, the entire basal area ($L \times W$) is used to determine I. However, on sloping sites, only the area below and downslope from the absorption bed is considered $[(B) \times (A + I)]$. The infiltrative rates used for the natural soil to size the downslope setback are given in Table 7-10. These rates assume that a clogging mat forms at the fill/natural soil interface, which may not be true. Since the percolating wastewater can and does move laterally from this area, these values are conservative. However, for soils with percolation rates faster than 60 min/in. (24 min/cm), the side slope criteria determine the basal area instead of the infiltration rate of

FIGURE 7-13
MOUND DIMENSIONS

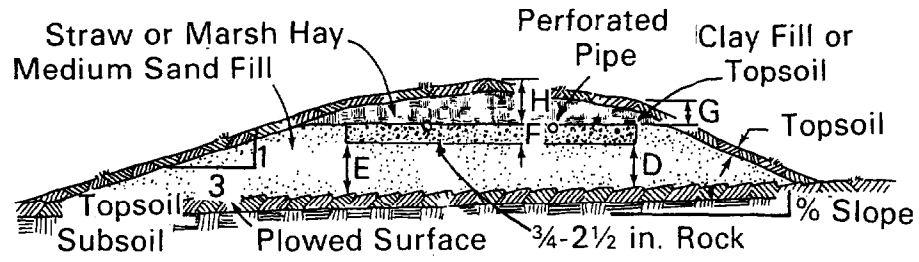

(A) Cross Section

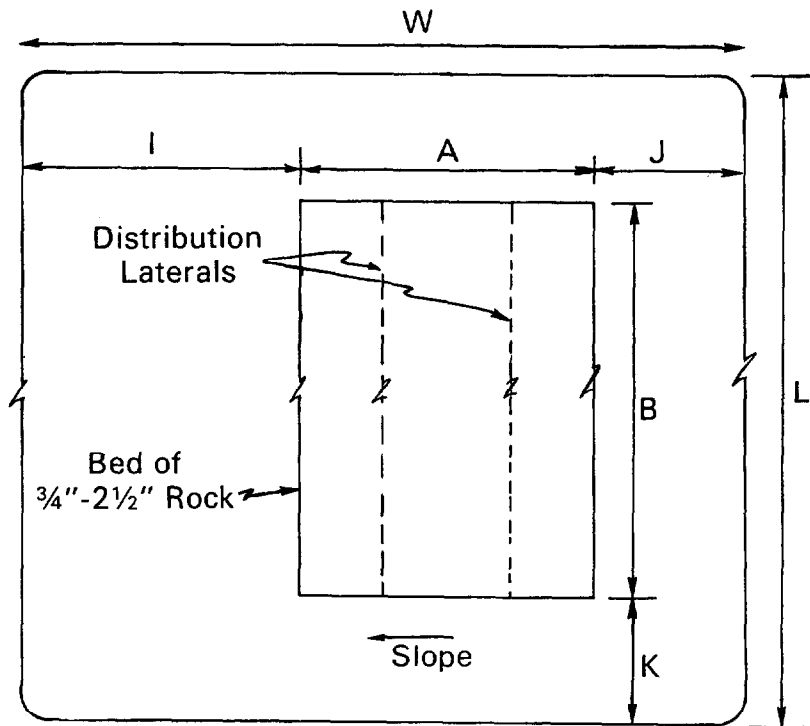

(B) Plan View

TABLE 7-9
DIMENSIONS FOR MOUND SYSTEMS^a (25)

| <u>Item</u> | <u>Dimension</u> |
|-------------------------------|------------------------------|
| Mound Height | |
| Fill Depth (D), ft | 1 (min) ^b |
| Absorption Bed Depth (F), in. | 9 (min) |
| Cap at Edge of Bed (G), ft | 1 ^c |
| Cap at Center of Bed (H), ft | 1.5 ^c |
| Mound Perimeter | |
| Downslope Setback (I) | Depends on Soil Permeability |
| Upslope Setback (J), ft | 10 ^d |
| Side Slope Setback (K), ft | 10 ^d |
| Side Slopes | No Steeper Than 3:1 |

^a Letters refer to lettered dimensions in Figure 7-13.

^b On sloping sites, this depth will increase downslope to maintain a level bed. In shallow soils where groundwater contamination is a concern, the fill depth should be increased to 2 ft.

^c A 4-6 in. depth of quality topsoil is included. This depth can be decreased by 6 in. in areas with mild winters. If depths less than 1 ft are used, erosion after construction must be avoided so sufficient soil covers the porous media.

^d Based on 3:1 side slopes. On sloping sites, (J) will be less if 3:1 side slope is maintained.

the top soil. It is only in the more slowly permeable soils where additional basal area is required, and a conservative design may be appropriate for these situations.

TABLE 7-10
INFILTRATION RATES FOR DETERMINING MOUND BASAL AREA (4)

| <u>Natural Soil Texture</u> | <u>Percolation Rate</u> min/in. | <u>Infiltration Rate</u> gpd/ft |
|------------------------------|------------------------------------|------------------------------------|
| Sand, Sandy Loam | 0-30 | 1.2 |
| Loams, Silt Loams | 31-45 | 0.75 |
| Silt Loams, Silty Clay Loams | 46-60 | 0.5 |
| Clay Loams, Clay | 61-120 | 0.25 |

d. Effluent Distribution

Although both gravity and pressure distribution networks have been used in mound systems, pressure distribution networks are superior (4)(24) (25). With pressure distribution, the effluent is spread more uniformly over the entire absorption area to minimize saturated flow through the fill and short circuiting, thus assuring good treatment and absorption. Approximately four doses per day is suggested (25). The design of pressure distributed networks is found in Section 7.2.8.

e. Porous Media

The porous media placed in the absorption bed of the mound is the same as described in Section 7.2.2.3.

f. Inspection Pipes

Inspection pipes are not necessary, but can be useful in observing ponding depths in the absorption bed (see Figure 7-6) of the mound.

Example 7.1: Calculation of Mound Dimensions and Pumping Requirements

Design a mound for a 3 bedroom house with the following site conditions. Letter notations used in Figure 7-13 are used in this example.

Natural Soil Texture: Clay loam
Percolation Rate at 20 in depth: 110 min/in.
Depth to Seasonally High Water Table: 20 in.
Slope: 6%
No bedrock or impermeable layers

Step 1: Select the Site. The mound site should be selected prior to locating the house and the road when possible. Consider all criteria listed in Table 7-7 for possible mound locations on the lot. Consider the difficulties in construction of the mound at the various locations. Evaluate all criteria, then pick the best site.

Step 2: Select Suitable Fill Material. It may be necessary to make a subjective judgement on the quality of fill material versus transportation costs. The ideal fill material may not be readily available and thus selection of lesser quality fill may be practical. If finer, the loading rates used to design the absorption bed may have to be reduced. Assume a medium texture sand for this example. The design infiltration rate is 1.2 gpd/ft² (Table 7-8).

Step 3: Estimate Design Flow. Peak flow is estimated from the size of the building. In this instance, 150 gpd/bedroom is assumed (see Chapter 4).

Step 4: Size Absorption Bed.

$$\text{Absorption Bed Area} = \frac{450 \text{ gpd}}{1.2 \text{ gpd/ft}^2} = 375 \text{ ft}^2$$

Step 5: Calculate Absorption Bed Dimension. The bed must parallel the site contour. Since the natural soil is slowly permeable, it is desirable to run the bed along the contour as far as possible. In this example, assume sufficient area exists for a 65-ft length bed.

$$\text{Bed Width (A)} = \frac{375 \text{ ft}^2}{65 \text{ ft}} = 5.8 \text{ ft or } 6 \text{ ft}$$

Bed Dimensions: A = 6 ft
B = 65 ft

Step 6: Calculate Mound Dimensions.

a. Mound Height

Fill Depth (D) = 1 ft (Table 7-9)

Fill Depth (E) = D + [(Slope) x (A)]

= 1 ft + [(0.06) x (6)]

= 1.4 ft (This is only approximate. Critical factor is construction of level bed bottom.)

Bed Depth (F) = 9 in. (min) (Table 7-9). (A minimum of 6 in. must be below the inverts of the distribution laterals.)

Cap at Edge of Bed (G) = 1 ft (min) (Table 7-9)

Cap at Center of Bed (H) = 1-1/2 ft (min) (Table 7-9)

b. Mound Perimeter

Downslope Setback (I): The area below and downslope of the absorption bed and sloping sites must be sufficiently large to absorb the peak wastewater flow. Select the proper natural soil infiltration rate from Table 7-10. In this case, the natural soil infiltration rate is 0.25 gpd/ft².

Upslope Setback (J) = (mound height at upslope edge of bed) x (3:1 slope)

= [(D) + (E) + (G)] x (3)

= (1.0 + 0.75 + 1.0) x (3)

= (2.75) x (3)

= 8.25 ft (This will be less because of natural ground slope, use 8 ft.)

Side Slope Setback (K) = (mound height at bed center) x (3:1 slope)

$$= \left[\frac{(D) + (E)}{2} + (F) + (H) \right] x (3)$$

$$\begin{aligned}
&= \left[\frac{1.0 + 1.4}{2} + 0.75 + 1.5 \right] \times (3) \\
&= (3.5) \times (3) \\
&= 10.5 \text{ ft, or } 11 \text{ ft}
\end{aligned}$$

$$\text{Basal Area Required} = (B) \times [(I) + (A)]$$

$$= \frac{450 \text{ gpd}}{0.25 \text{ gpd/ft}^2} = 1,800 \text{ ft}^2$$

$$(I) + (A) = \frac{1,800}{(B)}$$

$$(I) = \frac{1,800}{(B)} - (A)$$

$$= \frac{1,800}{65} - 6$$

$$= 21.7 \text{ ft, or } 22 \text{ ft}$$

Check to see that the downslope setback (I) is great enough so as not to exceed a 3:1 slope:

$$(\text{mound height at downslope edge of bed}) \times (3:1 \text{ slope})$$

$$= [(E) + (F) + (G)] \times (3)$$

$$= (1.4 + 0.75 + 1.0) \times (3)$$

$$= 9.5 \text{ ft}$$

Since the distance needed to maintain a 3:1 slope is less than the distance needed to provide sufficient basal area, (I) = 22 ft

$$\text{Mound Length (L)} = (B) + 2(K)$$

$$= 65 + 2(11)$$

$$= 87 \text{ ft}$$

$$\text{Mound Width (W)} = (J) + (A) + (I)$$

$$= 8 + 6 + 22$$

$$= 36 \text{ ft}$$

Step 7: Design Effluent Distribution Network. See Section 7.2.8(f).

7.2.4.4 Construction

a. Site Preparation

Good construction techniques are essential if the mound is to function properly. The following techniques should be considered:

- Step 1: Rope off the site to prevent damage to the area during other construction activity on the lot. Vehicular traffic over the area should be prohibited to avoid soil compaction.
- Step 2: Stake out the mound perimeter and bed in the proper orientation. Reference stakes set some distance from the mound perimeter are also required in case the corner stakes are disturbed.
- Step 3: Cut and remove any excessive vegetation. Trees should be cut at ground surface and the stumps left in place.
- Step 4: Measure the average ground elevation along the upslope edge of the bed to determine the bottom elevation of the bed.
- Step 5: Install the delivery pipe from the dosing chamber to the mound. Lay the pipe below the frost line or slope it uniformly back to the dosing chamber so it may drain after dosing. Back fill and compact the soil around the pipe.
- Step 6: Plow the area within the mound perimeter. Use a two bottom or larger moldboard plow, plowing 7 to 8 in. (18 to 20 cm) deep parallel to the contour. Single bottom plows should not be used, as the trace wheel runs in every furrow, compacting the soil. Each furrow should be thrown upslope. A chisel plow may be used in place of a moldboard plow. Roughening the surface with backhoe teeth may be satisfactory, especially in wooded sites with stumps. Rototilling is not recommended because of the damage it does to the soil structure. However, rototilling may be used in granular soils, such as sands.

Plowing should not be done when the soil is too wet. Smearing and compaction of the soil will occur. If a sample of the soil taken from the plow depth forms a wire when rolled between the palms, the soil is too wet. If it crumbles, plowing may proceed.

b. Fill Placement

- Step 1: Place the fill material on the upslope edges of the plowed area. Keep trucks off the plowed area. Minimize traffic on the downslope side.
- Step 2: Move the fill material into place using a small track type tractor with a blade. Always keep a minimum of 6 in. of material beneath the tracks of the tractor to minimize compaction of the natural soil. The fill material should be worked in this manner until the height of the fill reaches the elevation of the top of the absorption bed.
- Step 3: With the blade of the tractor, form the absorption bed. Hand level the bottom of the bed, checking it for the proper elevation. Shape the sides to the desired slope.

c. Distribution Network Placement

- Step 1: Carefully place the coarse aggregate in the bed. Do not create ruts in the bottom of the bed. Level the aggregate to a minimum depth of 6 in. (15 cm).
- Step 2: Assemble the distribution network on the aggregate. The manifold should be placed so it will drain between doses, either out the laterals or back into the pump chamber. The laterals should be laid level.
- Step 3: Place additional aggregate to a depth of at least 2 in. (5 cm) over the crown of the pipe.
- Step 4: Place a suitable backfill barrier over the aggregate.

d. Covering

- Step 1: Place a finer textured soil material such as clay or silt loam over the top of the bed to a minimum depth of 6 in. (15 cm).
- Step 2: Place 6 in. (15 cm) of good quality topsoil over the entire mound surface.
- Step 3: Plant grass over the entire mound using grasses adapted to the area. Shrubs can be planted around the base and up the sideslopes. Shrubs should be somewhat moisture tolerant since the downslope perimeter may become moist during early spring and late fall. Plantings on top of the mound should be drought

tolerant, as the upper portion of the mound can become dry during the summer.

7.2.4.5 Operation and Maintenance

a. Routine Maintenance

A properly designed and constructed mound should operate satisfactorily with virtually no regular maintenance.

b. Rehabilitation

Three failure conditions may occur within the mound. They are (1) severe clogging at the bottom of the absorption area, (2) severe clogging at the fill material and natural soil interface, and (3) plugging of the distribution network. Usually these failures can be easily corrected.

If severe clogging occurs at the bottom of the absorption bed, its cause should first be determined. If it is due to failure to maintain the pretreatment unit, hydrogen peroxide to oxidize the accumulated organics at the infiltrative surface could be used. The chemical can be applied directly to the bed or through the dosing chamber. Because of the danger in handling this strong oxidant, this treatment should be done by professionals.

If the clogging is due to overloading or unusual wastewater characteristics, efforts should be made to reduce the wastewater volume or strength. It may be necessary to enlarge the mound. The mound cap should be removed and the aggregate in the absorption bed stripped out. The area downslope of the mound should be plowed and additional fill added to enlarge the mound to the proper size. The absorption bed can then be reconstructed.

Severe clogging at the fill and natural soil interface will cause surface seepage at the base of the mound. This area should be permitted to dry and the downslope area plowed. Additional fill can then be added. If this does not correct the problem, the site may have to be abandoned.

Partial plugging of the distribution piping may be detected by extremely long dosing times. The ends of the distribution laterals should be exposed and the pump activated to flush out any solid material. If necessary, the pipe can be rodded.

7.2.4.6 Considerations for Multi-Home and Commercial Wastewaters

Designs of the mound system for larger flows follow the same design principles as for smaller flows. In cluster systems serving more than five homes, however, peak flow estimates can be reduced because of flow attenuation, but contributions from infiltration through the collection system must be included. Peak flow estimates should be based on the total number of people to be served (see Chapter 4). Rates of infiltration vary with the type of collection sewer used (19)(20).

With commercial flows, the character of the wastewater is an important consideration. Proper pretreatment is necessary if the character is significantly different than domestic wastewater.

Modifications to the design of the mound system may be desirable for larger flows on sloping sites or in slowly permeable soils. In both instances, the absorption area should be broken up into a series of trenches or smaller beds. This is beneficial on sloping sites because the beds can be tiered to reduce the amount of fill required (see Figure 7-14). Depths of fill material below beds should not exceed 4 to 5 ft (1.3 to 1.7 m) because differential settling will cause the bed to settle unevenly. If the system is tiered, each trench or bed must be dosed individually. This can be done by automatic valving or alternating pumps or siphons.

In sites with slowly permeable soils, breaking the absorption area into smaller trenches or beds helps distribute the effluent over much wider areas. Spacing of the beds or trenches should be sufficient so that the wastewater contributed from one trench or bed is absorbed by the natural soil before it reaches the lower trench or bed (see Table 7-10). The beds or trenches should be as long as the site allows. A long bed, broken into several shorter systems, each served by a pump or siphon, is preferred over two or more short parallel beds, especially in soils where the effluent moves downslope.

Flexibility in operation should also be incorporated into systems serving larger flows, since a failure can create a significant problem. Alternating bed systems should be considered. A three-bed system is suggested where each bed contains 50% of the required absorption area (19). Two beds are always in operation, providing 100% of the needed infiltrative surface. The third bed is alternated into service on a yearly schedule. Thus, each field is in service for two years and "rested" for one year to rejuvenate. The third bed also acts as a standby unit in case one bed fails. The idle fields can be put into service immediately while the failed bed is rehabilitated.

FIGURE 7-14
TIERED MOUND SYSTEM

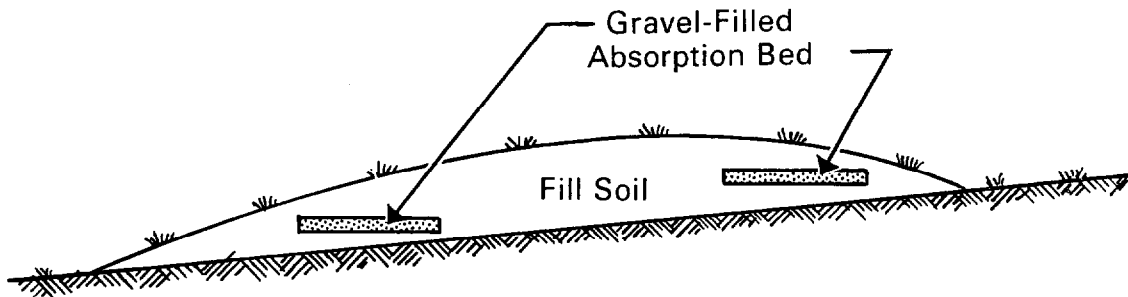

7.2.5 Fill Systems

7.2.5.1 Description

Fill systems may be used on sites with slowly permeable soils overlying sands and sandy loams where construction of a conventional system below the tight soil horizons may be ruled out. If the depth from the top surface of the underlying sand or sandy loam to the seasonally high water table or bedrock is inadequate to construct a trench or bed system, the slowly permeable soil may be stripped away and replaced with a sandy fill material to provide 2 to 4 ft (0.6 to 1.2 m) of unsaturated soil. A trench or bed system may then be constructed within the fill.

Mound systems would also be suitable designs for these conditions and may be less expensive to construct, but fill systems offer some advantages. If the soils overlying the sands or sandy loams are very slowly permeable, the size of a fill system may be smaller than that of a mound permitting their installation in smaller areas. Also, fill systems usually have less vertical relief above the natural grade than do mounds. This may be desirable for landscaping purposes.

7.2.5.2 Application

a. Site Considerations

The use of fills is restricted to sites where unsuitable surface soils may be stripped away without damaging the underlying soils. Therefore, fills are limited to sites where the underlying soils are sands or sandy loams and the seasonally high water table or bedrock surface is not within 1 ft (0.3 m) of the sand or sandy loam surface. If the depth to the seasonally high water table or bedrock is greater than 3 to 5 ft (0.9 to 1.5 m) from the sandy or sandy loam surface, a fill system is not necessary. A deep trench or bed system can be constructed directly in the more permeable underlying area.

Once the fill is placed, the site must meet all the site and soil criteria required for trench or bed systems (see Table 7-1).

b. Influent Wastewater Characteristics

The influent wastewater must be free of settleable solids, fats, and grease. Water softener wastes are not harmful, nor is the normal use of household chemicals and detergents.

7.2.5.3 Design

Since fill systems differ from trench and bed systems only in that they are constructed in a filled area, the design of fill systems is identical to trenches and beds. The only unique features are the sizing of the area to be filled and the fill selection. Uniform distribution of the wastewater over the infiltrative surface through a pressurized network is suggested to maintain groundwater quality (11).

a. Sizing of the Filled Area

A minimum separation distance of 5 ft (1.5 m) between the sidewalls of the absorption trenches or bed, and the edge of the filled area should be maintained. This allows for sidewall absorption and lateral movement of the wastewater.

If a perched water table condition occurs in the surface soils that are to be moved, provisions should be made to prevent this water from flowing into the filled area. Curtain drains, perimeter drains or barrier trenches may be necessary upslope or around the filled area to remove this water (see Section 7.2.6).

b. Fill Selection

The fill material should be similar in texture to the underlying sand or loamy sand. The backfill material used to cover the system should be finer textured to shed surface runoff. It may be the original soil that was removed.

7.2.5.4 Construction

Care should be exercised in removing the unsuitable soil prior to filling to prevent excessive disturbance of the sandy soil below. The machinery should always operate from unexcavated areas. The top few inches of the sand or sandy loam soil should be removed to ensure that all the unsuitable soil is stripped.

The exposed surface should be harrowed or otherwise broken up to a depth of 6 in. (15 cm) prior to filling. This eliminates a distinct interface forming between the fill and the natural soil that would disrupt liquid movement.

Once the fill has been placed, construction of the absorption system can proceed as for trenches or beds in sands. However, if the fill depth is greater than 4 ft (1.2 m), the fill should be allowed to settle before construction begins. This may require a year to settle naturally. To avoid this delay, the fill can be spread in shallow lifts and each mechanically compacted. This must be done carefully, however, so that layers of differing density are not created. The fill should be compacted to a density similar to the underlying natural soil.

7.2.5.5 Operation and Maintenance

The operation and maintenance of fill systems are identical to trenches and beds constructed in sands. The fill system lends itself very well to treatment with chemical oxidants or reconstruction in the same area.

7.2.6 Artificially Drained Systems

7.2.6.1 Description

High water tables that limit the use of trenches, beds or seepage pits can sometimes be artificially lowered to permit the use of these disposal methods. Vertical drains, curtain drains and underdrains are commonly used subsurface drainage techniques. Soil and site conditions determine which method is selected.

Curtain drains and vertical drains are used to lower perched water tables. These methods are most effective where the perched water is moving laterally under the soil absorption site. The drains are placed upstream of the absorption area to intercept the groundwater as it flows into the area.

Curtain drains are trench excavations in which perforated drainage pipe is placed. These are placed around the upslope perimeter of the soil absorption site to intercept the groundwater moving into the area (see Figure 7-15). If the site has sufficient slope, the drains are brought to the surface downslope to allow free drainage. On level sites, pumps must be used to remove the collected water. If the restrictive layer that creates the water table is thin and overlies permeable soil, vertical drains may be used. These are trench excavations made through the restrictive layer into the more permeable soil below and backfilled with porous material (see Figure 7-16). Thus, water moving toward the excavation is able to drain into the underlying soil. Vertical drains are susceptible to sealing by fine sediment transported by the water.

Underdrains are used where water tables exist 4 to 5 ft (1.2 to 1.5 m) below the surface in permeable soils. The drains are similar to curtain drains in construction, but several drains may be necessary to lower the water table sufficiently (see Figure 7-17). Depth and spacing of the drains are determined by the soil and water table characteristics.

7.2.6.2 Site Considerations

Successful design of artificially drained systems depends upon the correct diagnosis of the drainage problem. The source of the groundwater and its flow characteristics must be determined to select the proper method of drainage. Particular attention must be given to soil stratification and groundwater gradients.

FIGURE 7-15

CURTAIN DRAIN TO INTERCEPT LATERALLY MOVING PERCHED WATER TABLE CAUSED BY A SHALLOW, IMPERMEABLE LAYER

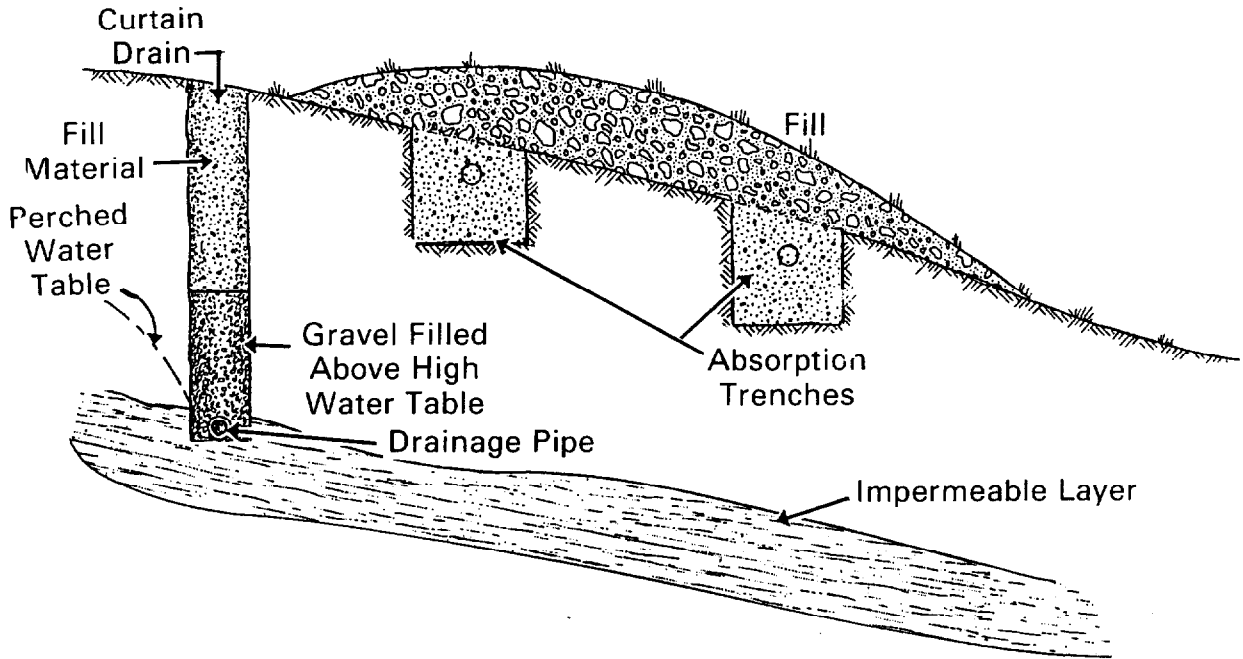

FIGURE 7-16

VERTICAL DRAIN TO INTERCEPT LATERALLY MOVING PERCHED WATER TABLE CAUSED BY A SHALLOW, THIN, IMPERMEABLE LAYER

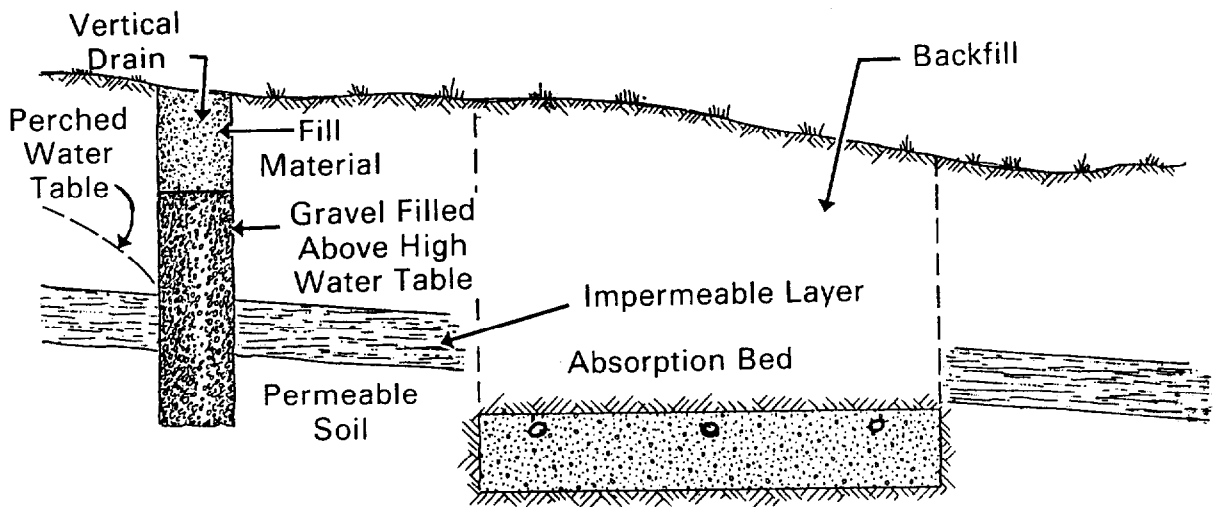
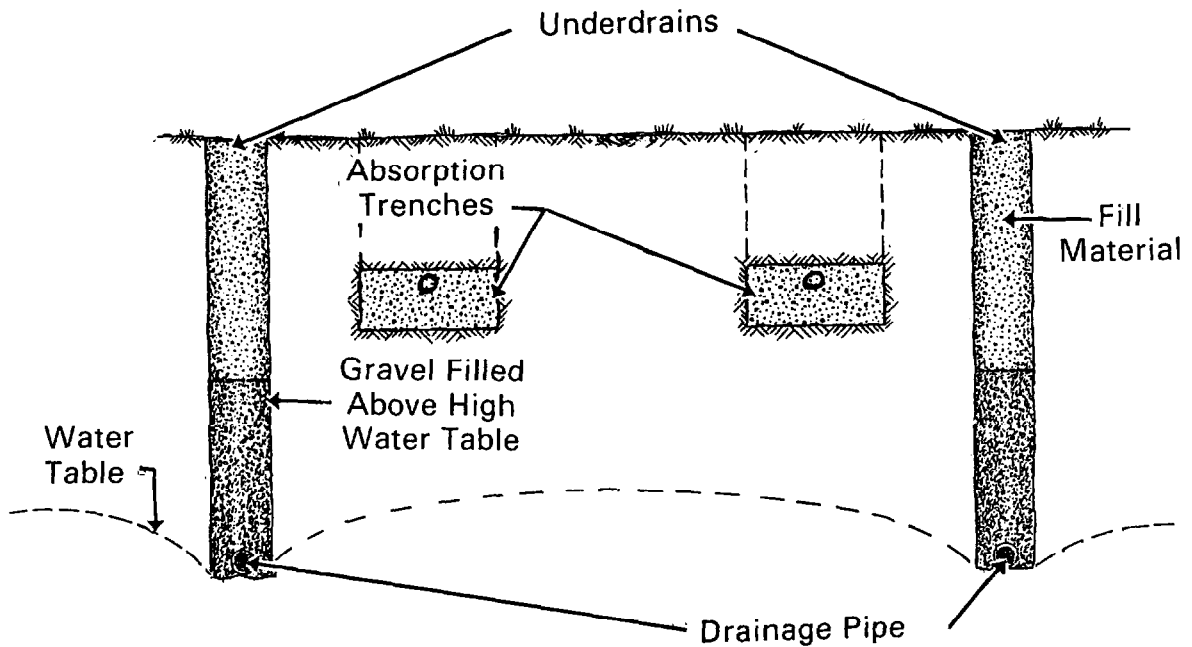

FIGURE 7-17
UNDERDRAINS USED TO LOWER WATER TABLE



a. Subsurface Drainage Problems

There is an unlimited variety of subsurface drainage problems but the most common ones can be grouped into four general types (26). These are: (1) free water tables, (2) water tables over artesian aquifers, (3) perched water tables, and (4) lateral groundwater flow problems.

Free water tables typically are large, slow moving bodies of water fed by surface waters, precipitation, and subsurface percolation from other areas. In the lower elevations of the drainage basin, the groundwater is discharged into streams, on the ground surface in low areas, or by escape into other aquifers. The groundwater elevation fluctuates seasonally. The slope of a free water table surface is usually quite gentle.

Where the soil is permeable, underdrains can be used to lower the water table sufficiently to permit the installation of trench or bed disposal systems. In fine textured soils of slow permeability, however, subsurface drainage is impractical.

An artesian aquifer is a groundwater body confined by an impervious layer over the aquifer. Its pressure surface (the elevation to which it would rise in a well tapping the aquifer) is higher than the local water table, and may even rise above the ground surface. Pressure in the aquifer is caused by the weight of a continuous body of water that is higher than the local water table. Leaks at holes or weak points in the confining layer create an upward flow, with the hydraulic head decreasing in the upward direction. The groundwater moves in the direction of the decreasing gradient and escapes as seepage at the ground surface or moves laterally into other aquifers.

Areas with this problem are impractical to drain. The water removed is continually replenished from the aquifer. This requires relatively deep and closely spaced drains and pumped discharges. Onsite disposal options other than soil absorption systems should be investigated in areas with shallow artesian aquifers.

In stratified soils, a water table may develop that is separated from the free water table by a slowly permeable layer, i.e., a perched water table. This occurs when surface sources of water saturate the soil above the layer due to slow natural drainage. Methods employed to drain perched water tables depend upon the particular site conditions. Vertical drains, curtain drains or underdrains may be used.

Lateral groundwater flow problems are characterized by horizontal groundwater movement across the area. This flow pattern is usually created by soil stratification or other natural barriers to flow.

The depth, orientation and inclination of the strata or barriers determine the drainage method used and its location. Curtain drains or vertical drains are usually employed to intercept the water upstream of the area to be drained.

b. Site Evaluation

Soils with high water tables that may be practical to drain to make a site suitable for a trench or bed system are ones having (1) shallow perched water tables, (2) lateral groundwater flow, or (3) free water tables in coarse textured soils. Soils that are saturated for prolonged

periods, particularly on level sites, are not practical to drain. Other disposal methods should be investigated for such sites.

Because each of these drainage problems require different solutions, it is important that the site evaluation be done in sufficient detail to differentiate between them. Where the need for subsurface drainage is anticipated, topographic surveys, soil profile descriptions and estimation of the seasonally high groundwater elevations and gradients should be emphasized. Evaluation of these site characteristics must be done in addition to other characteristics that are evaluated for subsurface disposal (see Chapter 3).

Topographic Surveys: Topographic maps of the site with 1 to 2 ft (0.3 to 0.6 m) contour intervals are useful as base maps on which water and soils information can be referenced. Water table elevations, seep areas and areas with vegetation indicative of seasonal or prolonged high water tables should be located on the map. Elevations of ridges, knolls, rock outcrops and natural drainage ways should also be noted. This information is useful in establishing the source of the groundwater, its direction of flow, and the placement of the drainage system.

Soil Profile Descriptions: The soil profile must be carefully examined to identify the type of drainage problem and the extent of seasonal water table fluctuations. Soil stratification and soil color are used to make these determinations.

Soil stratification or layering may or may not be readily visible. Soil texture, density, color, zones of saturation and root penetration aid in identifying layers of varying hydraulic conductivity (see Chapter 3). The thickness and slope of each layer should be described. Deep uniform soils indicate that the drainage problem must be handled as a free water table problem. Stratified soils indicate a perched or lateral flow groundwater problem.

The soil color helps to identify zones of periodic and continuous saturation. Soil mottling occurs when the soil is periodically saturated, and gleyed soil indicates continuous saturation (see Chapter 3). The highest elevation of the mottling provides an estimate of the seasonally high water table, while the top of the gleyed zone indicates the seasonally low water table elevation. It is particularly important to establish the extent of the seasonal fluctuations to determine if drainage is practical. If the seasonally low water table is above the elevation to which the soil must be drained to make the site acceptable, drainage must be provided throughout the year. If pumps are used to remove the water, costs may be excessive and other alternatives should be investigated.

Groundwater Elevation and Gradients: To accurately determine groundwater elevations and gradients, observation wells or piezometers are used. Observation wells are used to observe groundwater fluctuations throughout a year or more. If several are strategically placed about the area, the local gradient can also be established by measuring the water surface elevation in each well. Piezometers differ from observation wells in that they are constructed so that there is no leakage around the pipe. The water surface elevation measured establishes the hydrostatic pressure at the bottom of the well. If placed at several depths, they can be used to establish whether artesian conditions exist. For construction of piezometers and interpretation of results, see USDA, "Drainage of Agricultural Land" (26).

The measured or estimated water table elevations for a specific time period are plotted on the topographic map. By drawing the contours of the water table surface from these plots, the direction of groundwater movement is determined, since movement is perpendicular to the groundwater contours. This helps locate the source of the water and how to best place the drainage network.

7.2.6.3 Design

a. Selection of Drainage Method

In designing a subsurface drainage system, the site characteristics are evaluated to determine which method of drainage is most appropriate. Table 7-11 presents the drainage method for various site characteristics. In general, shallow, lateral flow problems are the easiest drainage problems to correct for subsurface wastewater disposal. Since the use of underdrains for onsite disposal systems has been very limited, other acceptable disposal methods not requiring drains should first be considered.

b. Curtain Drains

Curtain drains are placed some distance upslope from the proposed soil absorption system to intercept the groundwater, and around either end of the system to prevent intrusion. On sites with sufficient slope, the drain is extended downslope until it surfaces, to provide free drainage. The drain is placed slightly into the restrictive layer to ensure that all the groundwater is intercepted. A separation distance from the soil absorption system is required to prevent insufficiently treated wastewater from entering the drain. This distance depends on the soil permeability and depth of drain below the bottom of the absorption system; however, a separation distance of 10 ft is commonly used.

TABLE 7-11
DRAINAGE METHODS FOR VARIOUS SITE CHARACTERISTICS

| <u>Site Characteristics</u> | <u>Drainage Problem</u> | <u>Drainage Method</u> |
|---|--------------------------|--|
| Saturated or mottled soils above a restrictive layer with water source located at a higher elevation; site usually sloping | Lateral flow | Curtain drain Vertical drain ^a |
| Saturated or mottled soils above a restrictive layer; soil below restrictive layer is unsaturated; site is level or only gently sloping | Perched water table | Underdrain ^b Vertical drain ^a |
| Deep uniform soils mottled or saturated | Free water table | Underdrain ^b |
| Saturated soils above and below restrictive layer with hydraulic gradients increasing with depth | Artesian-fed water table | Avoid |

^a Use only where restrictive layer is thin and underlying soil is reasonably permeable.

^b Soils with more than 70% clay are difficult to drain and should be avoided.

The size of the drain is dependent upon the soil permeability, the size of the area drained, and the gradient of the pipe. Silt traps are sometimes provided in the drain to improve the quality of the discharged drainage. These units may require infrequent cleaning to maintain their effectiveness.

c. Vertical Drains

Vertical drains may be used to intercept a laterally flowing perched water table. Separation distances between the drain and the bottom of the soil absorption system are the same as for curtain drains to maintain an unsaturated zone under the absorption system.

The size and placement of the drain depends upon the relative permeabilities of the saturated soil and the soil below the restrictive layer, and the size of the area to be drained. The infiltration surface of the vertical drain (sidewalls and bottom area) must be sized to absorb all the water it receives. The width and depth of the drain below the restrictive layer is calculated by assuming an infiltration rate for the underlying soil. If clay and silt are transported by the groundwater, the infiltration rate will be less than the saturated conductivity of the soil. Clogging of the vertical drain by silt can be a significant problem. Unfortunately, experience with these drains in wastewater disposal is lacking.

d. Underdrains

Underdrains must be located to lower the water table to provide the necessary depth of unsaturated soil below the infiltrative surface of the soil absorption system, and to prevent poorly treated effluent from entering the drain. Sometimes, a network of drains is required throughout the area where the soil absorption system is located. The depth and spacing of the drains is determined by the soil permeability, the size of the area to be drained, and other factors. Where necessary, however, see USDA Drainage of Agricultural Land (26) for design procedures.

7.2.6.4 Construction

a. Curtain Drains and Underdrains

To maximize infiltration of the groundwater into the pipe, a coarse, porous material such as gravel, crushed rock, etc., should be placed under and above the pipe. The porous material is extended above the

high water table elevation. To prevent silt from entering the pipe while the disturbed area is stabilizing, the tops of the joints or perforations should be covered with waterproof building paper or the pipe jacketed with mesh. Natural soil material is used for the remainder of the backfill (27).

The outlet must be protected from small animals. The outlet may be covered with a porous material such as rock or gravel. Various commercial outlet protection devices are also available (26).

b. Vertical Drains

Vertical drains are dug to the desired depth and width, and are back-filled with a coarse, porous media such as coarse sand, 1/4- to 1/2-in (0.6 to 1.3 cm) gravel, or similar material, to a level above the high perched water table elevation. Natural soil materials are used for the remainder of the backfill.

7.2.6.5 Maintenance

A well-designed and constructed drainage system requires little maintenance. The outlets should be inspected routinely to see that free drainage is maintained. If a silt trap is used, it should be inspected annually to determine the need for cleaning.

7.2.7 Electro-Osmosis

7.2.7.1 Description

Electro-osmosis is a technique used to drain and stabilize slowly permeable soils during excavation. A direct current is passed through the soil, which draws the free water in the soil pores to the cathode (28). The water collects at the cathode and is pumped out. Steel well points serve as cathodes, and steel rods driven between wells are used as anodes. Common practice is to install the electrodes approximately 15 ft (4.6 m) apart, and apply a 30- to 180-volt potential. Current flow is 20 to 30 amps (28).

Recently, a similar technique has been applied to onsite wastewater disposal in soils with percolation rates slower than 60 min/in. (24 min/cm). A galvanic cell is constructed out of natural materials, which requires no external power source. This cell is capable of generating a

0.7- to 1.3-volt potential (29). Conventional absorption trenches are constructed and a mineral rock-filled anode is installed immediately adjacent to the trench. Coke-filled cathodes with graphite cores are installed some distance from the trench (see Figure 7-18). The water that moves to the cathode is claimed to be removed by evapotranspiration (30). These systems have been used successfully in California, Iowa, Minnesota, and Wyoming (29).

7.2.7.2 Site Considerations

Electro-osmosis systems were developed to enhance wastewater absorption in slowly permeable soils. They are used in soils with percolation rates slower than 60 min/in. (24 min/cm). Criteria for soil absorption trench or bed are presented in Table 7-1.

7.2.7.3 Design and Construction

The electro-osmosis system is patented. Design and construction of systems are done by licensees.

7.2.7.4 Operation and Maintenance

Once installed, no routine maintenance of the electrodes has been reported. Maintenance techniques for the soil absorption trench are presented in Section 7.2.2.5.

7.2.8 Effluent Distribution Network for Subsurface Soil Absorption Systems

Several different distribution networks are used in subsurface soil absorption systems. They include single line, closed loop, distribution box, relief line, drop box, and pressure networks. The objective of each is to apply the pretreated wastewater over the infiltrative surface.

The choice of one network over another depends on the type of system proposed and the method of wastewater application desired. Networks for the various types of systems versus the method of wastewater application are given in Table 7-12. Where more than one network is suitable, they are listed in order of preference.

FIGURE 7-18
 TYPICAL ELECTRO-OSMOSIS SYSTEM (30)

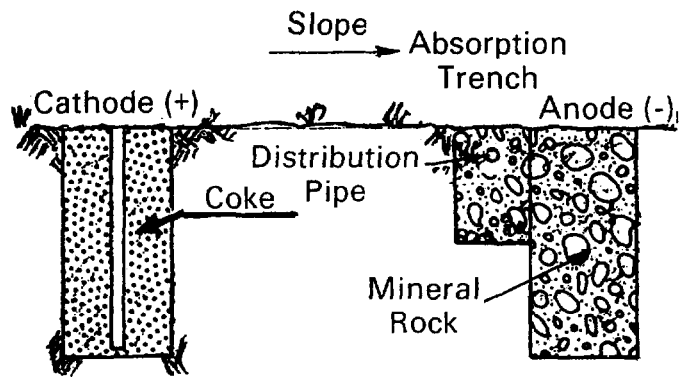
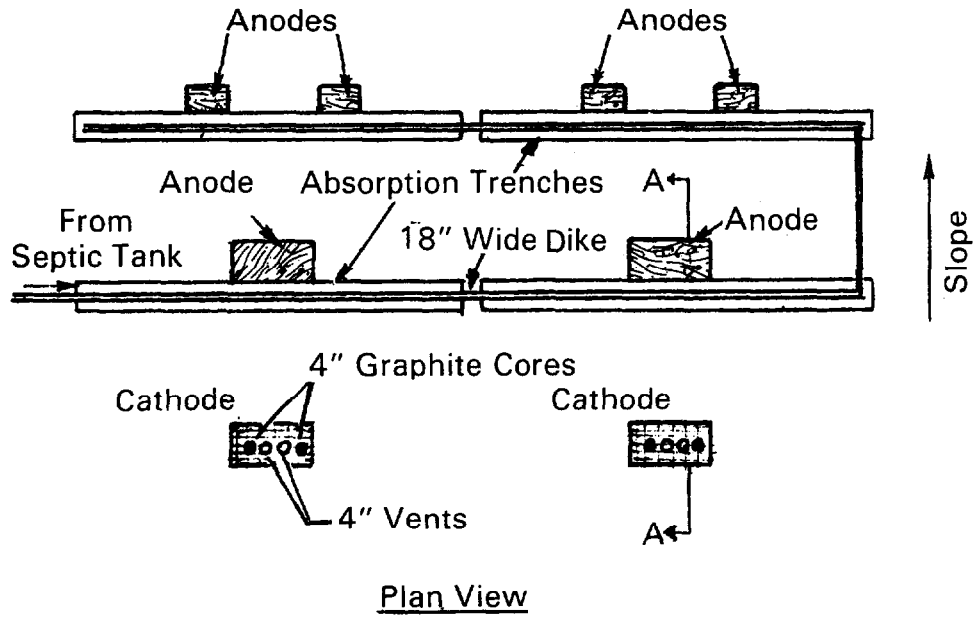

Section A-A

TABLE 7-12

DISTRIBUTION NETWORKS FOR VARIOUS SYSTEM DESIGNS AND APPLICATION METHODS^a

| <u>Method of Application</u> | <u>Single Trench</u> | <u>Multi-Trench (Fills, Drains) On Level Site</u> | <u>Multi-Trench (Drains) On Sloping Site</u> | <u>Beds (Fills, Drains)</u> | <u>Mounds</u> |
|------------------------------|-------------------------|---|--|---|----------------|
| Gravity | Single line | Drop box Closed loop Distribution box | Drop box Relief line Distribution box ^b | Closed loop Distribution box | Not applicable |
| Dosing | Single line Pressure | Closed loop Pressure Distribution box | Distribution box | Closed loop Pressure Distribution box | Not applicable |
| Uniform Application | Pressure | Pressure | Pressure ^c | Pressure | Pressure |

^a Distribution networks are listed in order of preference.

^b Use limited by degree of slope (see Section 7.2.8.1 d)

^c Because of the complexity of a pressure network on a sloping site, drop boxes or relief lines are suggested.

7.2.8.1 Design

a. Single Line

Single-line distribution networks are trenches loaded by gravity or dosing. The distribution line is a 3- to 4-in. (8- to 10-cm) diameter perforated pipe laid level in the center of the gravel-filled excavation (see Figure 7-19). The pipe is usually laid such that the holes are at or near the invert of the pipe. Where the length of single lines exceeds 100 ft (30 m), it is preferable to locate the wastewater inlet toward the center of the line.

b. Drop Box

Drop box networks are typically used for continuously ponded multi-trench systems on level to maximum sloping lots. It is a network that serially loads each trench to its full hydraulic capacity.

A drop box is a small, circular or square box with a removable cover. It has an inlet, one or two distribution lateral outlets, and an overflow. The lateral outlet inverts are located at or near the bottom of the box, all of the same diameter pipe. The overflow invert can be the same elevation as the crown of the lateral outlet, or up to 2 in. above it, to cause the full depth of the trench to flood. The inlet invert of the drop box may be at the same elevation as the overflow invert or a few inches above. An elevation difference of 1 to 2 in. (3 to 5 cm) between trenches is all that is needed to install a drop box network. The boxes may be buried, but it is suggested that the covers be left exposed for periodic inspection and maintenance (see Figure 7-20).

Drop boxes are installed at the wastewater inlet of each trench. The inlets may be located anywhere along the trench length. A solid wall pipe connects the overflow from the higher box to the inlet of the lower box. The first box in the network receives all the effluent from the pretreatment tank and distributes it into the first trench. When the first trench fills, the box overflows into the next trench. In this manner, each trench in the system is used successively to its full capacity. Thus, only the portion of the system required to absorb the wastewater is used. During periods of high flow or low absorptive capacity of the soil, more trenches will be used. When flows are low or during the hot dry summer months, the lower trenches may not be needed, so they may drain and dry out, automatically resting more trenches, which rejuvenates their infiltrative surfaces (11).

FIGURE 7-19
SINGLE LINE DISTRIBUTION NETWORK

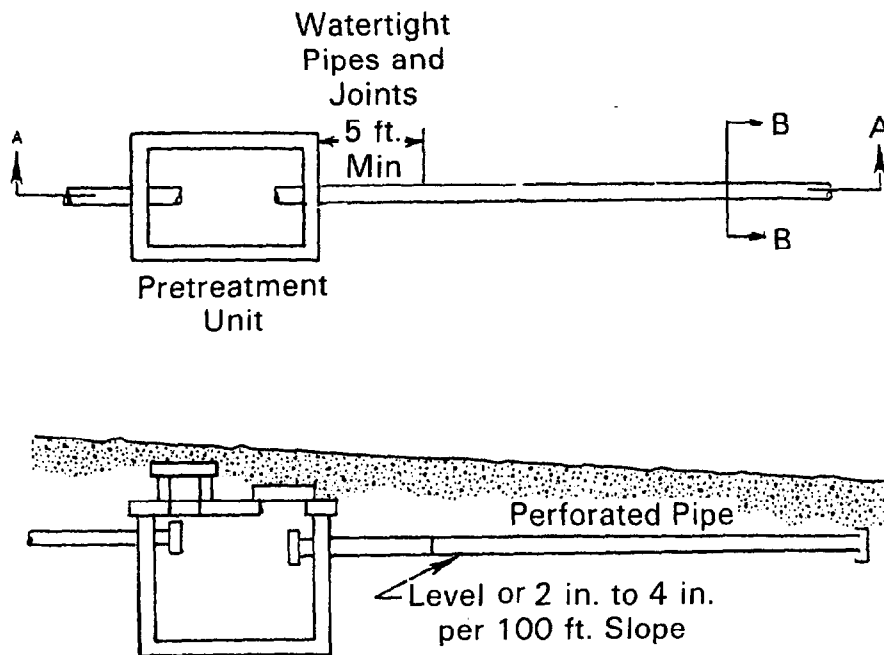

Section A-A

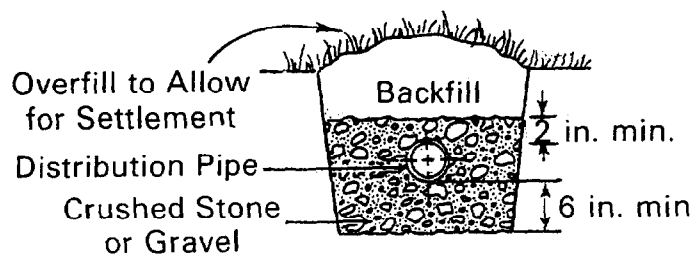

Section B-B

FIGURE 7-20

DROP BOX DISTRIBUTION NETWORK ([AFTER (22)])

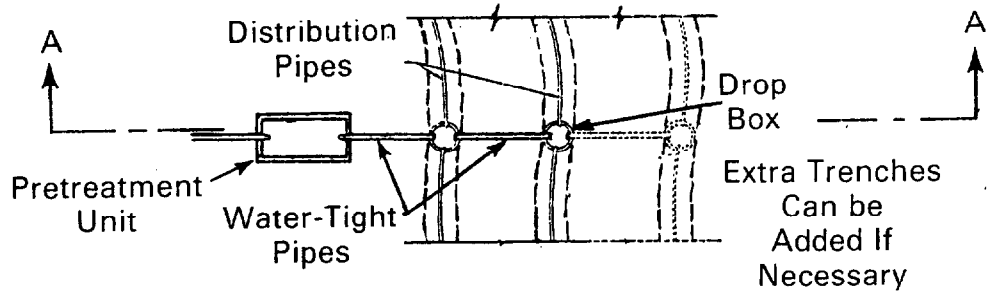
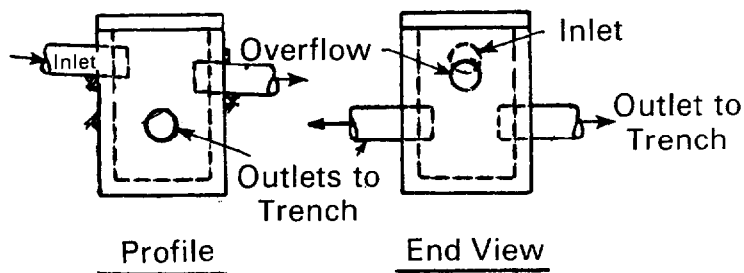
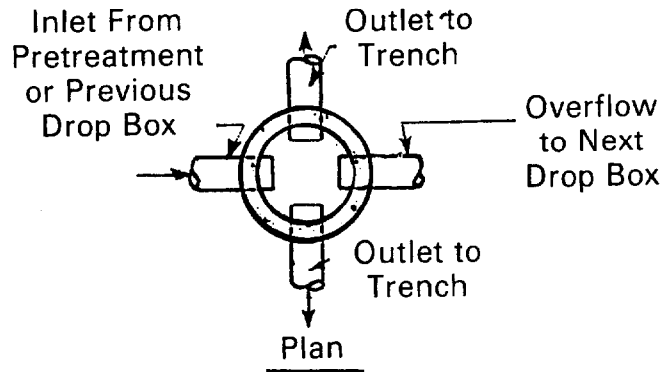

Plan

Covers May be Exposed at Surface if Insulated in Cold Climates

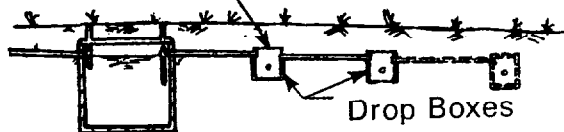

Section A-A

The liquid level in the trenches is established by the elevation of the overflow invert leading to the succeeding drop box. If the elevation of this invert is near the top of the rock in the trench, the entire trench sidewall will be utilized, maximum hydrostatic head will be developed to force the liquid into the surrounding soil, and evapotranspiration by plants during the growing season will be maximized by providing a supply of liquid to the overlying soil.

The drop box design has several advantages over single lines, closed loop, and distribution box networks for continuously ponded systems. It may be used on steeply sloping sites without surface seepage occurring unless the entire system is overloaded. If the system becomes overloaded, additional trenches can be added easily without abandoning or disturbing the existing system. Drop box networks also permit unneeded absorption trenches to rest and rejuvenate. The lower trenches are rested automatically when flows are low or infiltration capacity is high. The upper trenches may be rested when necessary by plugging the drop box lateral outlets.

c. Closed Loop

In absorption systems where the entire infiltrative surface is at one elevation, such as in beds or multi-trench systems on level or nearly level sites, closed loop networks may be used. The distribution pipe is laid level over the gravel filled excavation and the ends connected together with additional pipe with ell or tee fittings. In beds, the parallel lines are usually laid with 3 to 6 ft (0.9 to 1.8 m) spacings. A tee, cross, or distribution box may be used at the inlet to the closed system (See Figure 7-21).

d. Distribution Box

Distribution box networks may be used in multi-trench systems or beds with independent distribution laterals. They are suitable for all gravity-flow systems.

The distribution laterals in the network extend from a common watertight box called the distribution box. The box may be round or rectangular, with a single inlet, and an outlet for each distribution lateral. It has an exposed, removable cover. Its purpose is to divide the incoming wastewater equally between each lateral. To achieve this objective, the outlet inverts must be at exactly the same elevation. The inlet invert should be about 1 in. above the outlet inverts. Where dosing is employed or where the slope of the inlet pipe imparts a significant velocity to the wastewater flow, a baffle should be placed in front of the inlet to prevent short-circuiting.

FIGURE 7-21

CLOSED LOOP DISTRIBUTION NETWORK

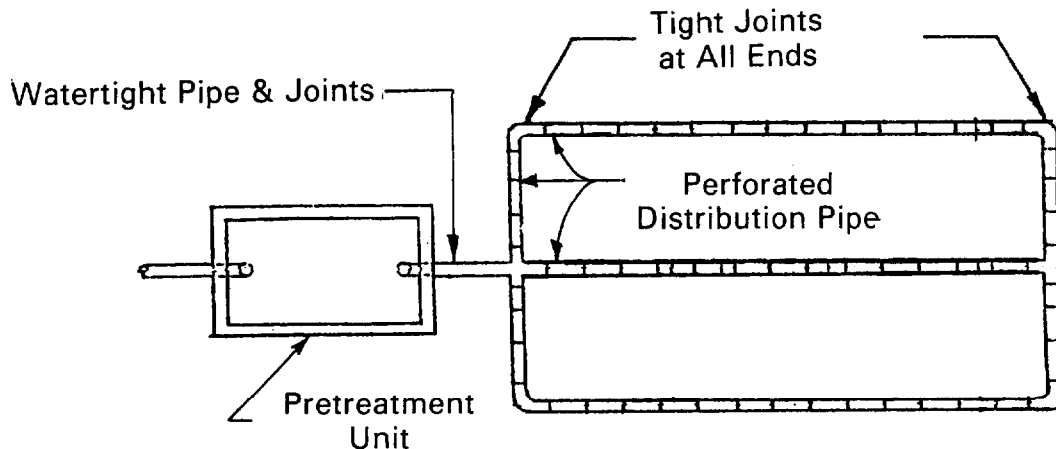

Distribution box networks are suggested only for absorption systems located on level or gently sloping sites, where the system can be installed so that the ground surface elevation above the lowest trench is above the box outlets (11). This is because it is difficult to prevent the distribution box from settling (11)(17)(31). If the box were to settle unevenly so that the lowest trench received a greater share of the effluent, wastewater would seep onto the ground surface unless the distribution lateral of the lowest trench were at a high enough elevation to back up the wastewater into the box, where it could flow into a different lateral. Therefore, to utilize the full capacity of each trench in the system, distribution box networks should be used only where each trench can back up into the distribution box (see Figure 7-22). On steeply sloping sites, other networks should be used, unless great care is used to construct the distribution box on a stable footing. If used for dividing flow between independent trenches, any combination of trenches can be rested by plugging the appropriate outlets.

e. Relief Line

Relief line networks may be used in place of drop box networks in continuously ponded multi-trench systems on sites up to the maximum permissible slopes. The network provides serial distribution as in drop

FIGURE 7-22

DISTRIBUTION BOX NETWORK

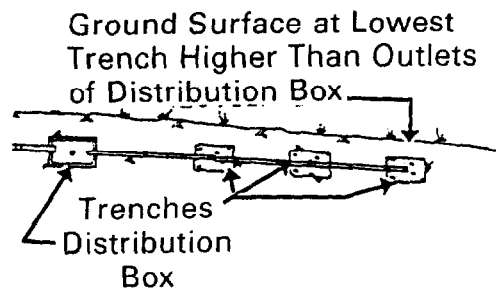
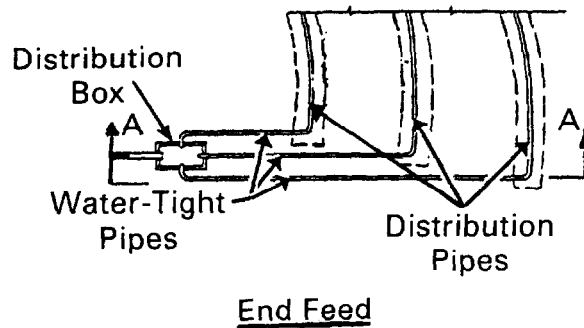
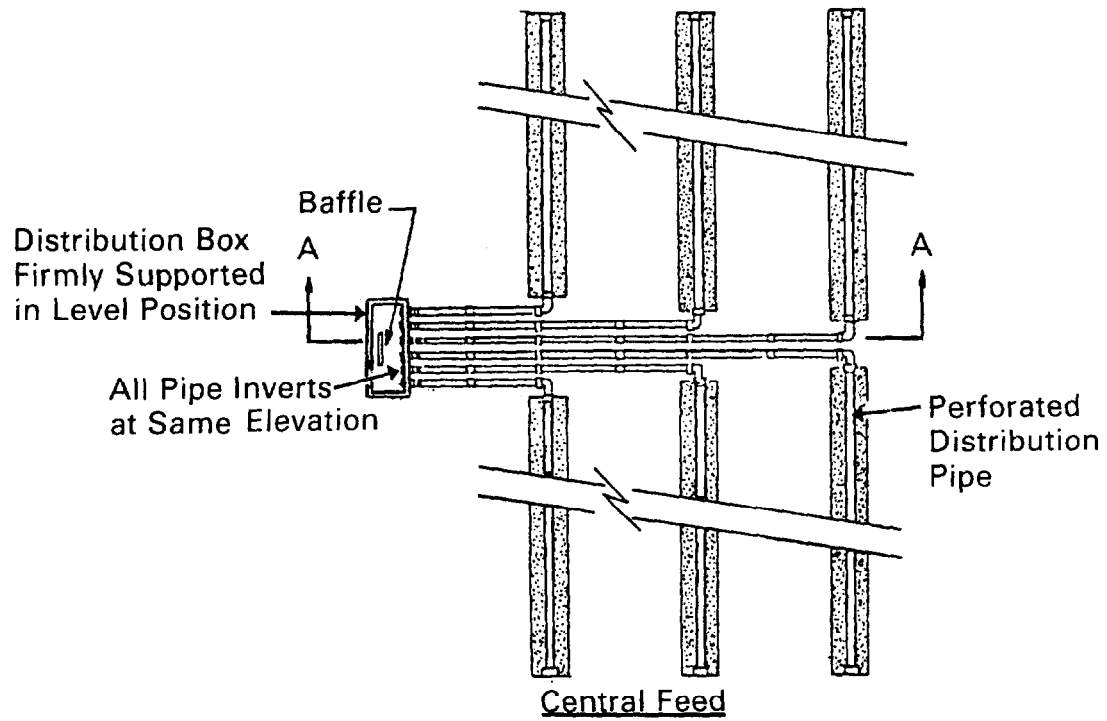

Section A-A

box networks (see Figure 7-23). However, the design makes it more difficult to add trenches to the system and it does not permit the owner to manually rest the upper trenches.

The network uses overflow or relief lines between trenches in place of drop boxes. The invert of the overflow section should be located near the top of the porous media to use the maximum capacity of the trench, but it should be lower than the septic tank outlet invert. The invert of the overflow from the first absorption trench should be at least 4 in. lower than the invert of the pretreatment unit outlet. Relief lines may be located anywhere along the length of the trench, but successive trenches should be separated 5 to 10 ft (1.3 to 3.0 m) to prevent short-circuiting.

f. Pressure Distribution

If uniform distribution of wastewater over the entire infiltrative surface is required, pressure distribution networks are suggested. These networks may also be used in systems that are dosed since the mode of the network operation is intermittent.

To achieve uniform distribution, the volume of water passing out each hole in the network during a dosing cycle must be nearly equal. To achieve this, the pressure in each segment of pipe must also be nearly equal. This is accomplished by balancing the head losses through proper sizing of the pipe diameter, hole diameter and hole spacing. Thus, approximately 75 to 85% of the total headloss incurred is across the hole in the lateral, while the remaining 15 to 25% is incurred in the network delivering the liquid to each hole. The networks usually consist of 1- to 3-in. (3- to 8-cm) diameter laterals, connected by a central or end manifold of larger diameter. The laterals are perforated at their inverts with 1/4 to 1/2 in. (0.6 to 1.3 cm) diameter holes. The spacing between holes is 2 to 10 ft (0.6 to 3.0 m) (see Figures 7-24 to 27).

Pumps are used to pressurize the network, although siphons may be used if the dosing chamber is located at a higher elevation than the lateral inverts. The active dosing volume is about 10 times the total lateral pipe volume. This ensures more uniform distribution since the laterals, drained after each dose, must fill before the network can become properly pressurized. (See Section 8.3 for dosing chamber design.)

FIGURE 7-23

RELIEF LINE DISTRIBUTION NETWORK

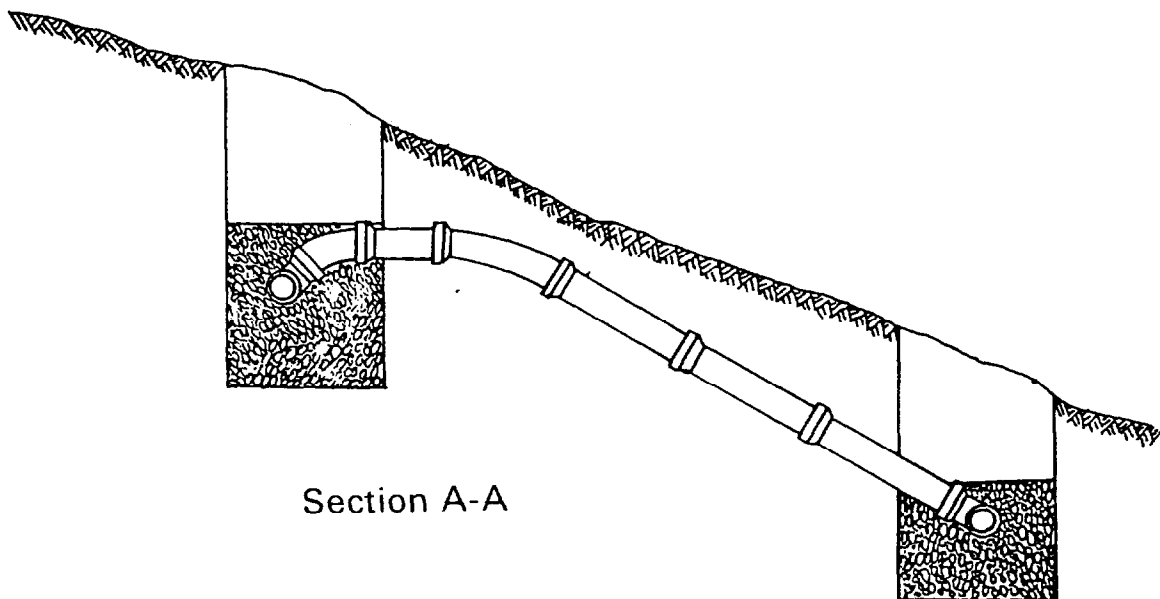
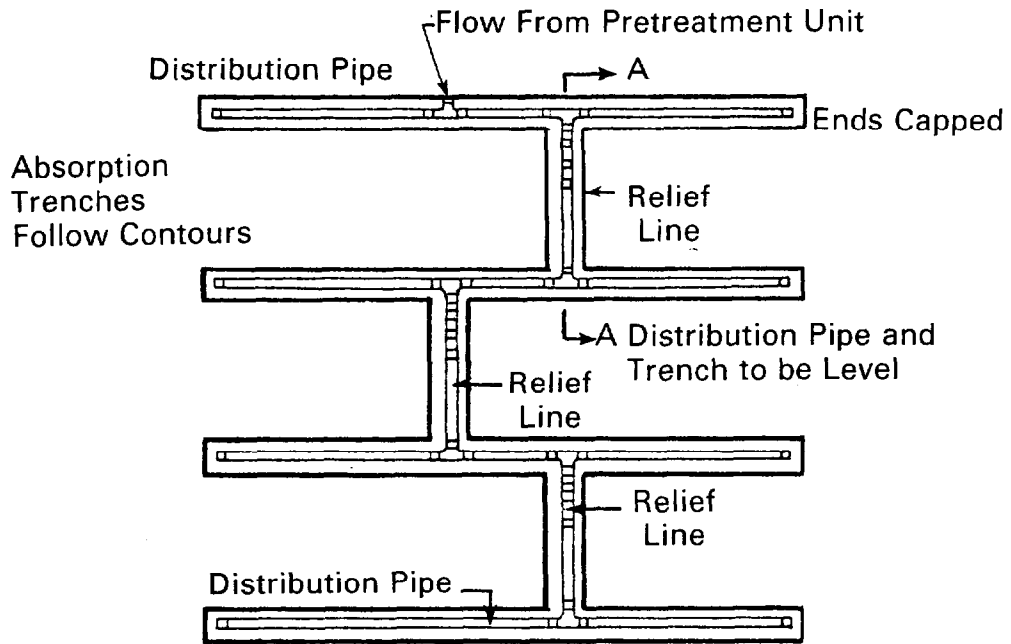

FIGURE 7-24
CENTRAL MANIFOLD DISTRIBUTION NETWORK

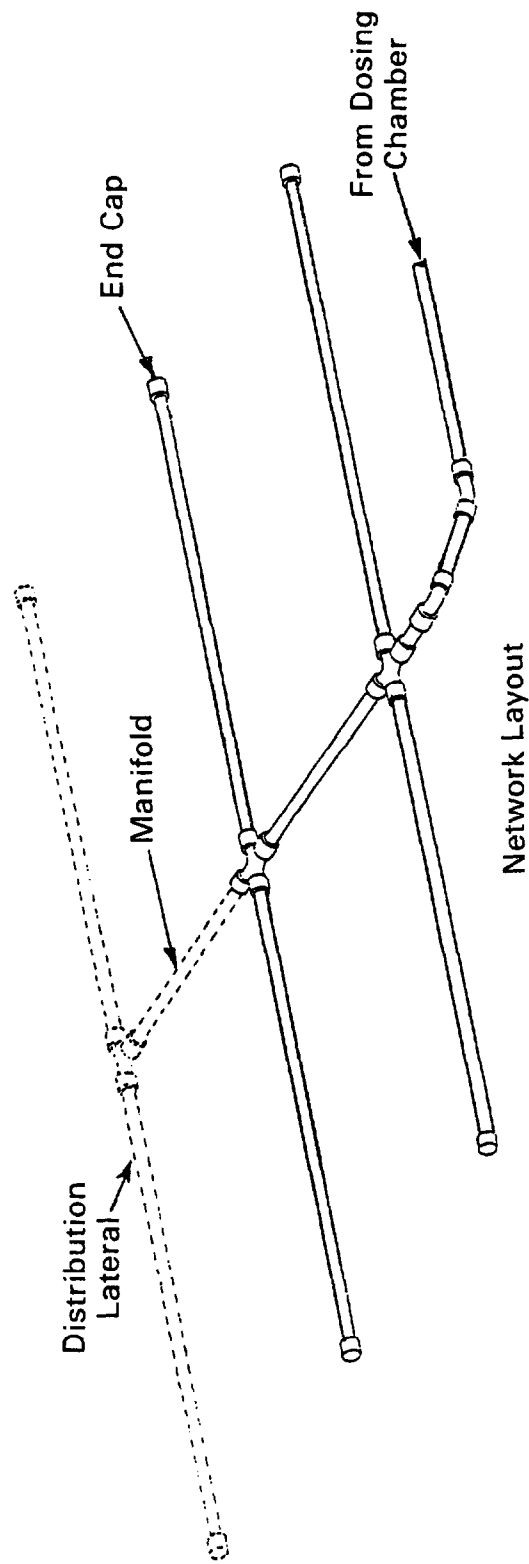

FIGURE 7-25
END MANIFOLD DISTRIBUTION NETWORK

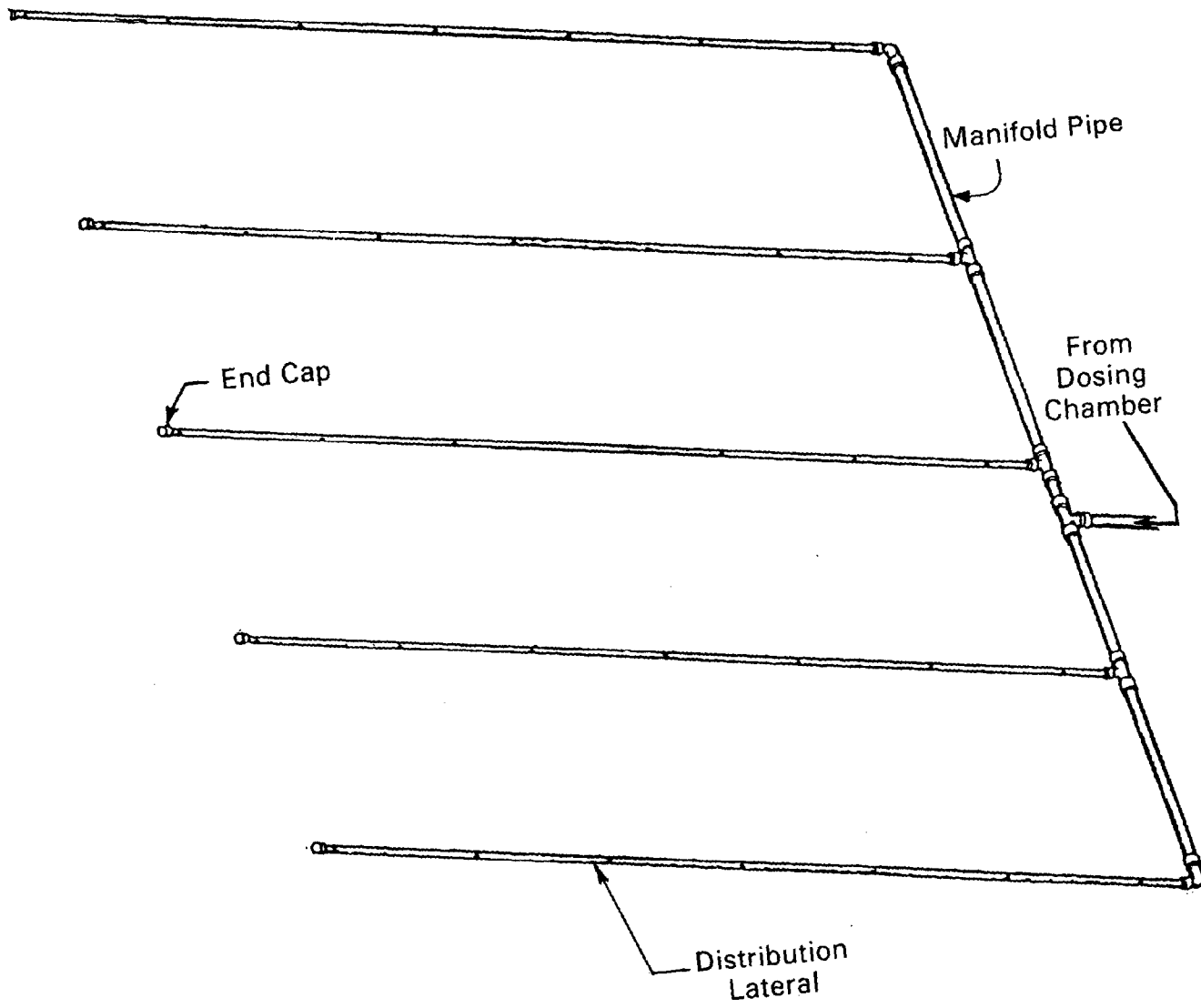

FIGURE 7-26

LATERAL DETAIL - TEE TO TEE CONSTRUCTION

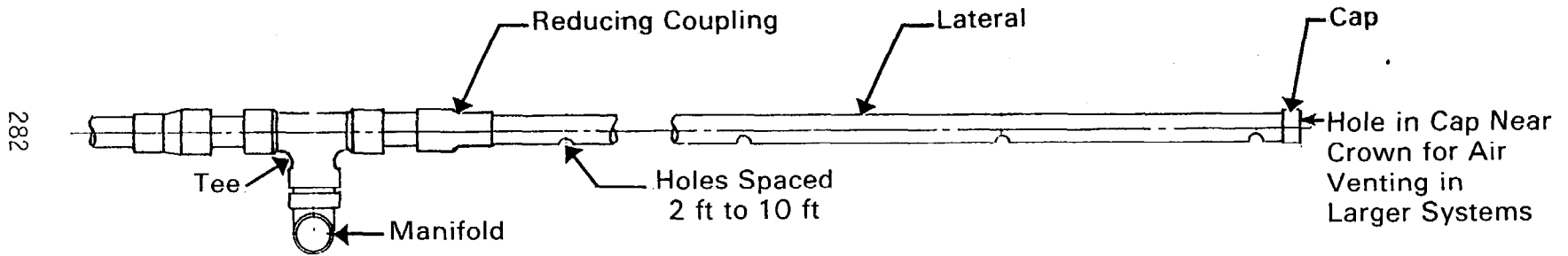
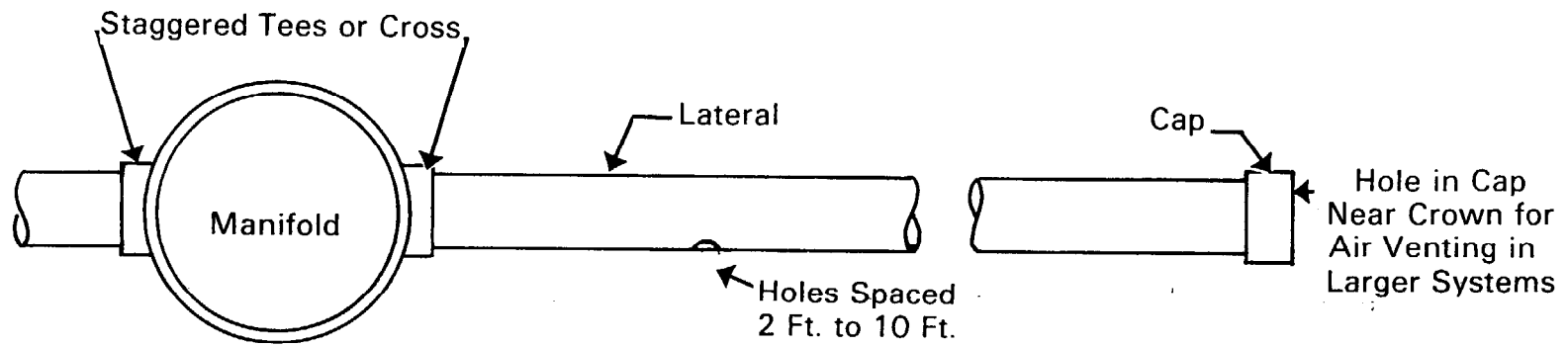

FIGURE 7-27

LATERAL DETAIL - STAGGERED TEES OR CROSS CONSTRUCTION



To simplify the design of small pressure distribution networks, Table 7-13, and Figures 7-28, 7-29, and 7-30, may be used. Examples 7-2 and 7-3 illustrate their use. Other design methods may be equally suitable, however.

TABLE 7-13
DISCHARGE RATES FOR VARIOUS SIZED HOLES
AT VARIOUS PRESSURES (gpm)

| Pressure | | Hole Diameter (in.) | | | | |
|----------|------|---------------------|------|------|------|------|
| ft | psi | 1/4 | 5/16 | 3/8 | 7/16 | 1/2 |
| 1 | 0.43 | 0.74 | 1.15 | 1.66 | 2.26 | 2.95 |
| 2 | 0.87 | 1.04 | 1.63 | 2.34 | 3.19 | 4.17 |
| 3 | 1.30 | 1.28 | 1.99 | 2.87 | 3.91 | 5.10 |
| 4 | 1.73 | 1.47 | 2.30 | 3.31 | 4.51 | 5.89 |
| 5 | 2.17 | 1.65 | 2.57 | 3.71 | 5.04 | 6.59 |

Example 7-2: Design of a Pressure Distribution Network for a Trench Absorption Field

Design a pressure network for an absorption field consisting of five trenches, each 3 ft wide by 40 ft long, and spaced 9 ft apart center to center.

- Step 1: Select lateral length. Two layouts are suitable for this system: central manifold (Figure 7-24) or end manifold (Figure 7-25). For a central manifold design, ten 20-ft laterals are used; for an end manifold design, five 40-ft laterals are required. The end manifold design is used in this example.
- Step 2: Select hole diameter and hole spacing for laterals. For this example, 1/4-in. diameter holes spaced every 30 in. are used, although other combinations could be used.

FIGURE 7-28

REQUIRED LATERAL PIPE DIAMETERS FOR VARIOUS HOLE DIAMETERS, HOLE SPACINGS, AND LATERAL LENGTHS^a
(FOR PLASTIC PIPE ONLY)

| Lateral Length (ft) | LATERAL DIAMETER (IN) | | | | | | | | | | | | | | | | | | | | | | | | | | | | | | | | | | |
|------------------------|---------------------------|---|---|---|---|---|---|----------------------------|---|---|---|---|---|---|---------------------------|---|---|---|---|---|---|----------------------------|---|---|---|---|---|---|---------------------------|---|--|--|--|--|--|
| | Hole Diameter (in) 1/4 | | | | | | | Hole Diameter (in) 5/16 | | | | | | | Hole Diameter (in) 3/8 | | | | | | | Hole Diameter (in) 7/16 | | | | | | | Hole Diameter (in) 1/2 | | | | | | |
| | Hole Spacing (ft) | | | | | | | Hole Spacing (ft) | | | | | | | Hole Spacing (ft) | | | | | | | Hole Spacing (ft) | | | | | | | Hole Spacing (ft) | | | | | | |
| | 2 | 3 | 4 | 5 | 6 | 7 | 2 | 3 | 4 | 5 | 6 | 7 | 2 | 3 | 4 | 5 | 6 | 7 | 2 | 3 | 4 | 5 | 6 | 7 | 2 | 3 | 4 | 5 | 6 | 7 | | | | | |
| 10 | 1" | | | | | | | 1" | | | | | | | 1" | | | | | | | 1" | | | | | | | 1" | | | | | | |
| 15 | 1" | | | | | | | 1" | | | | | | | 1" | | | | | | | 1" | | | | | | | 1" | | | | | | |
| 20 | 1" | | | | | | | 1" | | | | | | | 1" | | | | | | | 1" | | | | | | | 1" | | | | | | |
| 25 | 1" | | | | | | | 1" | | | | | | | 1" | | | | | | | 1" | | | | | | | 1" | | | | | | |
| 30 | 1" | | | | | | | 1" | | | | | | | 1" | | | | | | | 1" | | | | | | | 1" | | | | | | |
| 35 | 1" | | | | | | | 1" | | | | | | | 1" | | | | | | | 1" | | | | | | | 1" | | | | | | |
| 40 | 1" | | | | | | | 1" | | | | | | | 1" | | | | | | | 1" | | | | | | | 1" | | | | | | |
| 45 | 1" | | | | | | | 1" | | | | | | | 1" | | | | | | | 1" | | | | | | | 1" | | | | | | |
| 50 | 1" | | | | | | | 1" | | | | | | | 1" | | | | | | | 1" | | | | | | | 1" | | | | | | |

^a Computed for plastic pipe only. The Hazen-Williams equation was used to compute headlosses through each pipe segment (Hazen-Williams C= 150). The orifice equation for sharp-edged orifices (discharge coefficient = 0.6) was used to compute the discharge rates through each orifice. The maximum lateral length for a given hole and spacing was defined as that length at which the difference between the rates of discharge from the distal end and the supply end orifice reached 10 percent of the distal end orifice discharge rate.

FIGURE 7-30

NOMOGRAPH FOR DETERMINING THE MINIMUM DOSE VOLUME FOR A GIVEN LATERAL DIAMETER, LATERAL LENGTH, AND NUMBER OF LATERALS

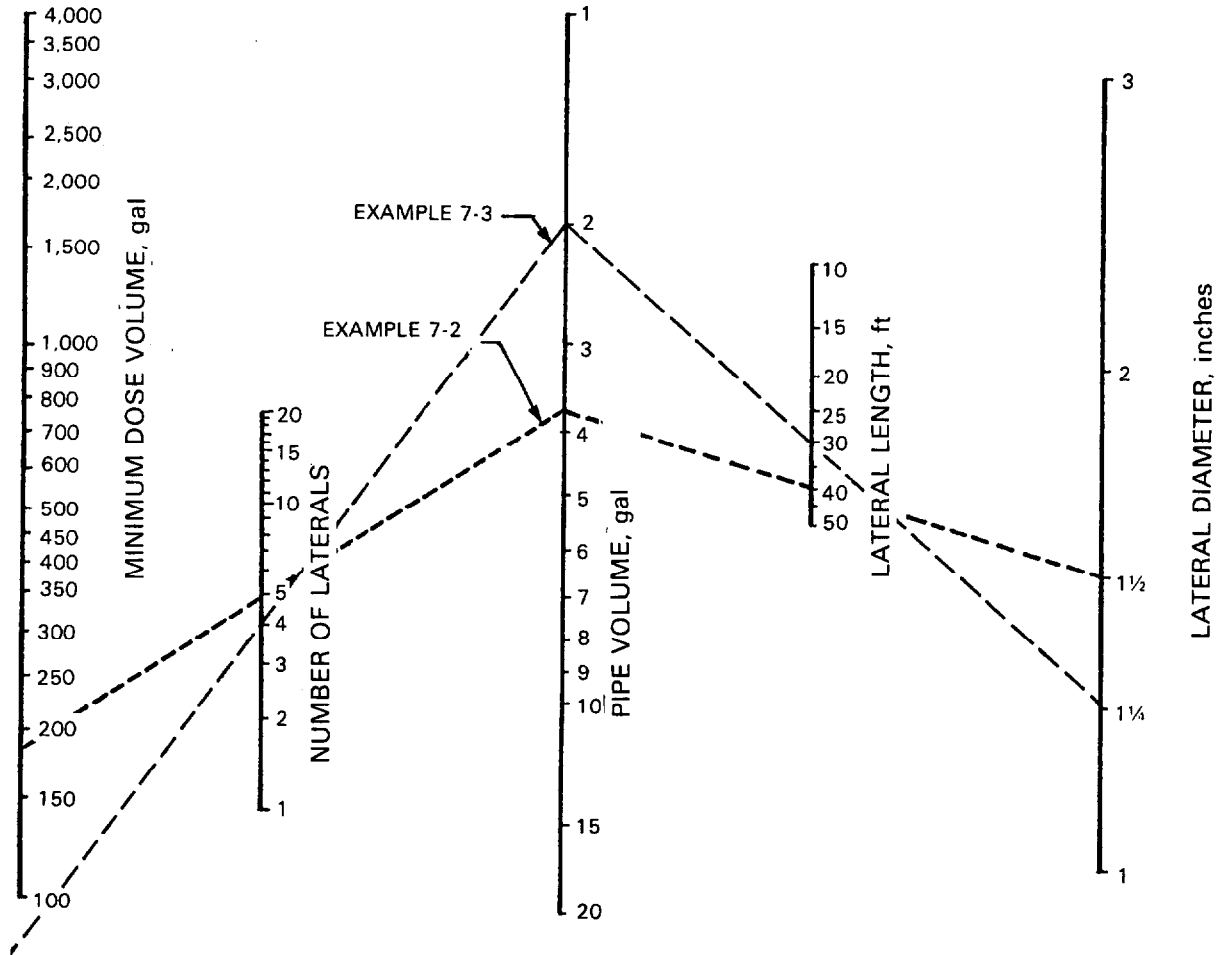

Step 3: Select lateral diameter. For 1/4-in. hole diameter, 30-in. hole spacing, and 40-ft length, Figure 7-28 indicates either a 1-1/4-in. or 1-1/2-in. diameter lateral could be used. The 1-1/2-in. diameter is selected for this example.

Step 4: Calculate lateral discharge rate. By maintaining higher pressures in the lateral, small variations in elevation along the length of the lateral and between laterals do not significantly affect the rates of discharge from each hole. This reduces construction costs, but increases pump size. For this example, a 2-ft head is to be maintained in the lateral. For a 1/4-in. hole at 2 ft of head, Table 7-13 shows the hole discharge rate to be 1.04 gpm.

$$\text{Number of holes/lateral} = \frac{40\text{-ft lateral length}}{2.5\text{-ft hole spacing}}$$

$$= 16$$

$$\text{Lateral discharge rate} = (16 \text{ holes/lateral}) \times (1.04 \text{ gpm/hole})$$

$$= 16.6 \text{ gpm/lateral}$$

Step 5: Select manifold size. There are to be five laterals spaced 9 ft apart. A manifold length of 36 ft is therefore required.

For five laterals and 16.6 gpm/lateral, Figure 7-29 indicates that a 3-in. diameter manifold is required.

Step 6: Determine minimum dose volume (Figure 7-30).

With: lateral diameter = 1-1/2 in.

lateral length = 40 ft

number of laterals = 5

Then: pipe volume = 3.7 gal

Minimum dose volume = approx. 200 gal

The final dose volume may be larger than this minimum depending on the desired number of doses per day (see Table 7-4).

See Figure 7-31 for completed network design.

Step 7: Determine minimum discharge rate.

$$\text{Minimum discharge rate} = (5 \text{ laterals}) \times (16.6 \text{ gpm/lateral})$$

$$= 83 \text{ gpm}$$

FIGURE 7-31

DISTRIBUTION NETWORK FOR EXAMPLE 7-2

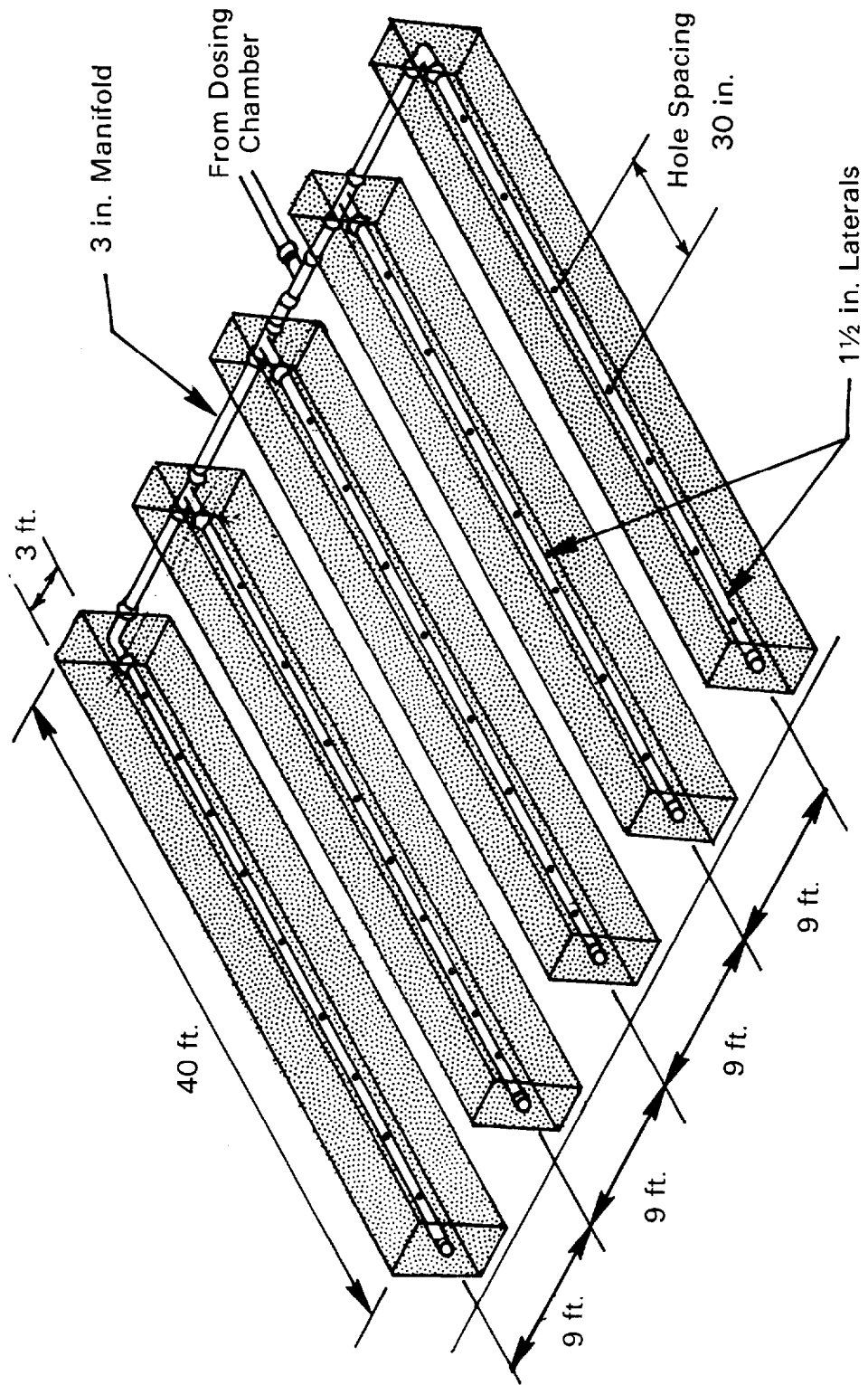

Step 8: Select proper pump or siphon.

For a pump system, the total pumping head of the network must be calculated. This is equal to the elevation difference between the pump and the distribution lateral inverts, plus friction loss in the pipe that delivers the wastewater from the pump to the network at the required rate, plus the desired pressure to be maintained in the network (the velocity head is neglected). A pump is then selected that is able to discharge the minimum rate (83 gpm) at the calculated pumping head.

For a siphon system, the siphon discharge pipe must be elevated above the lateral inverts at a distance equal to the friction losses and velocity head in the pipe that delivers the wastewater from the siphon to the network at the required rate, plus the desired pressure to be maintained in the network.

For this example, assume the dosing tank is located 25 ft from the network inlet, and the difference in elevation between the pump and the inverts of the distribution laterals is 5 ft.

a. Pump (assume 3-in. diameter delivery pipe)

1. Friction loss in 3-in. pipe at 83 gpm (from Table 7-14)

$$= 1.38 + \frac{3}{10} (1.73 - 1.38)$$

$$= 1.49 \text{ ft}/100 \text{ ft}$$

Friction loss in 25 ft

$$= (1.49 \text{ ft}/100 \text{ ft}) \times (25 \text{ ft})$$

$$= 0.4 \text{ ft}$$

2. Elevation Head = 5.0 ft

3. Pressure to be maintained = 2.0

Total pumping head = 7.4 ft

Therefore, a pump capable of delivering at least 83 gpm against 7.4 ft of head is required.

b. Siphon (assume 4-in. diameter delivery pipe)

1. Friction loss in 4-in. pipe at 83 gpm (from Table 7-14)

$$= 0.37 + \frac{3}{10} (0.46 - 0.37)$$

$$= 0.4 \text{ ft}/100 \text{ ft}$$

TABLE 7-14

FRICTION LOSS IN SCHEDULE 40 PLASTIC PIPE, C = 150
(ft/100 ft)

| Flow gpm | Pipe Diameter (in.) | | | | | | | | |
|-------------|---------------------|-------|-------|------|------|------|------|------|------|
| | 1 | 1-1/4 | 1-1/2 | 2 | 3 | 4 | 6 | 8 | 10 |
| 1 | 0.07 | | | | | | | | |
| 2 | 0.28 | 0.07 | | | | | | | |
| 3 | 0.60 | 0.16 | 0.07 | | | | | | |
| 4 | 1.01 | 0.25 | 0.12 | | | | | | |
| 5 | 1.52 | 0.39 | 0.18 | | | | | | |
| 6 | 2.14 | 0.55 | 0.25 | 0.07 | | | | | |
| 7 | 2.89 | 0.76 | 0.36 | 0.10 | | | | | |
| 8 | 3.63 | 0.97 | 0.46 | 0.14 | | | | | |
| 9 | 4.57 | 1.21 | 0.58 | 0.17 | | | | | |
| 10 | 5.50 | 1.46 | 0.70 | 0.21 | | | | | |
| 11 | | 1.77 | 0.84 | 0.25 | | | | | |
| 12 | | 2.09 | 1.01 | 0.30 | | | | | |
| 13 | | 2.42 | 1.17 | 0.35 | | | | | |
| 14 | | 2.74 | 1.33 | 0.39 | | | | | |
| 15 | | 3.06 | 1.45 | 0.44 | 0.07 | | | | |
| 16 | | 3.49 | 1.65 | 0.50 | 0.08 | | | | |
| 17 | | 3.93 | 1.86 | 0.56 | 0.09 | | | | |
| 18 | | 4.37 | 2.07 | 0.62 | 0.10 | | | | |
| 19 | | 4.81 | 2.28 | 0.68 | 0.11 | | | | |
| 20 | | 5.23 | 2.46 | 0.74 | 0.12 | | | | |
| 25 | | | 3.75 | 1.10 | 0.16 | | | | |
| 30 | | | 5.22 | 1.54 | 0.23 | | | | |
| 35 | | | | 2.05 | 0.30 | 0.07 | | | |
| 40 | | | | 2.62 | 0.39 | 0.09 | | | |
| 45 | | | | 3.27 | 0.48 | 0.12 | | | |
| 50 | | | | 3.98 | 0.58 | 0.16 | | | |
| 60 | | | | | 0.81 | 0.21 | | | |
| 70 | | | | | 1.08 | 0.28 | | | |
| 80 | | | | | 1.38 | 0.37 | | | |
| 90 | | | | | 1.73 | 0.46 | | | |
| 100 | | | | | 2.09 | 0.55 | 0.07 | | |
| 150 | | | | | | 1.17 | 0.16 | | |
| 200 | | | | | | | 0.28 | 0.07 | |
| 250 | | | | | | | 0.41 | 0.11 | |
| 300 | | | | | | | 0.58 | 0.16 | |
| 350 | | | | | | | 0.78 | 0.20 | 0.07 |
| 400 | | | | | | | 0.99 | 0.26 | 0.09 |
| 450 | | | | | | | 1.22 | 0.32 | 0.11 |
| 500 | | | | | | | | 0.38 | 0.14 |
| 600 | | | | | | | | 0.54 | 0.18 |
| 700 | | | | | | | | 0.72 | 0.24 |
| 800 | | | | | | | | | 0.32 |
| 900 | | | | | | | | | 0.38 |
| 1000 | | | | | | | | | 0.46 |

Friction loss in 25 ft

$$\begin{aligned} &= (0.4 \text{ ft}/100 \text{ ft}) \times (25 \text{ ft}) \\ &= 0.10 \text{ ft} \end{aligned}$$

2. Velocity head in delivery pipe

$$\text{Discharge rate} = 83 \text{ gpm} = 0.185 \text{ ft}^3/\text{sec}$$

$$\text{Area} = (1/4)\pi \left(\frac{4}{12}\right)^2 = 0.087 \text{ ft}^2$$

$$\text{Velocity} = \frac{0.185 \text{ ft}^3/\text{sec}}{0.087 \text{ ft}^2} = 2.13 \text{ ft}/\text{sec}$$

$$\begin{aligned} \text{Velocity head} &= \frac{(\text{Velocity})^2}{2g} \\ &= \frac{([2.13] \text{ ft}/\text{sec})^2}{2(32.2 \text{ ft}/\text{sec}^2)} \\ &= 0.07 \text{ ft} \end{aligned}$$

3. Pressure to be maintained

$$= \underline{2.0 \text{ ft}}$$

$$\text{Total} \quad \quad \quad 2.2 \text{ ft}$$

Minimum elevation of the siphon discharge invert above the lateral inverts must be 2.2 ft.

In summary, the final network design consists of five 40-ft laterals 1-1/2 in. in diameter connected with a 36-ft end manifold 3-in. in diameter, with the inlet from the dosing chamber at one end of the manifold. The inverts of the laterals are perforated with 1/4-in. holes spaced every 30 in.

Example 7-3: Design of a Pressure Distribution Network for a Mound

Design a pressure distribution network for the mound designed in Example 7-1.

Step 1: Select lateral length. A central manifold (Figure 7-24) design is used in this example.

$$\begin{aligned}\text{Lateral length} &= \frac{65 \text{ ft}}{2} - 0.5 \text{ ft (for manifold)} \\ &= 32 \text{ ft}\end{aligned}$$

Step 2: Select hole diameter and hole spacing for laterals. For this example, 1/4-in. diameter holes spaced every 30 in. are used, although other combinations could be used.

Step 3: Select lateral diameter. For 1/4-in. hole diameter, 30-in. hole spacing, and 32-ft lateral length, Figure 7-28 indicates that either a 1-1/4-in. or 1-1/2-in. diameter lateral could be used. The 1-1/4-in. diameter is selected for this example.

Step 4: Calculate lateral discharge rate. A 2-ft head is to be maintained in the lateral.

For 1/4-in. hole at 2 ft of head, Table 7-13 shows the hole discharge rate to be 1.04 gpm.

$$\begin{aligned}\text{Number of holes per lateral} &= \frac{32\text{-ft lateral length}}{2.5\text{-ft hole spacing}} \\ &= 13\end{aligned}$$

$$\text{Lateral discharge rate} = (13 \text{ holes/lateral}) \times (1.04 \text{ gpm/hole})$$

$$= 13.5 \text{ gpm/lateral}$$

Step 5: Select manifold size. There are to be four laterals (two on either side of the center manifold) spaced 3 ft apart. A manifold length of less than 5 ft is required (see Figure 7-32).

For four laterals, 13.5 gpm/lateral, and manifold length less than 5 ft, Figure 7-29 indicates that a 1-1/2-in. diameter manifold is required.

FIGURE 7-32
DISTRIBUTION NETWORK FOR EXAMPLE 7-3

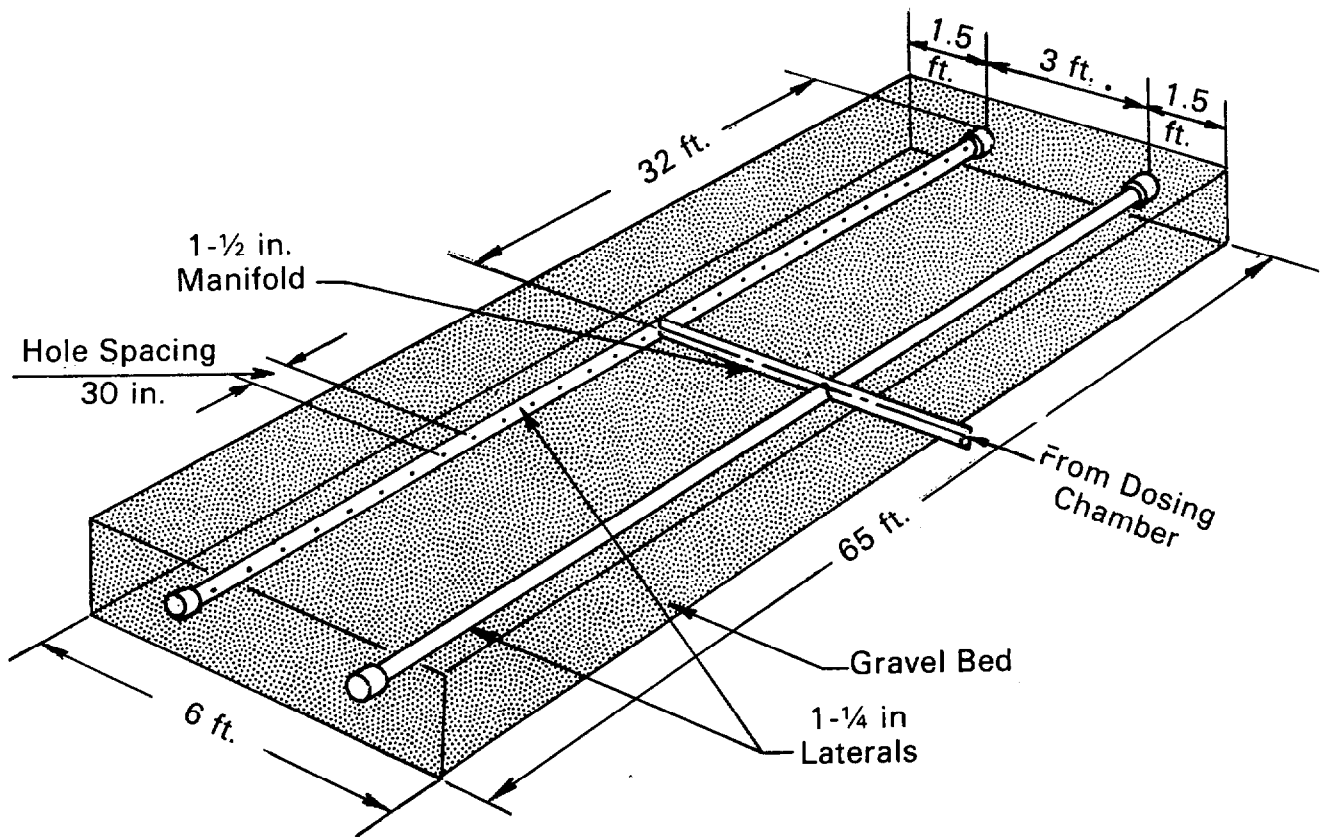

Step 6: Determine minimum dose volume (Figure 7-30).

With: lateral diameter = 1-1/4 in.
lateral length = 32 ft
number of laterals = 4

Then: pipe volume = 2 gal
Minimum dose volume = <100 gal

From Table 7-4, for a medium texture sand, 4 doses/day are desirable. Therefore, the dose volume is:

$$\frac{450 \text{ gpd}}{4} = 112 \text{ gal/dose}$$

Step 7: Determine minimum discharge rate.

Minimum discharge rate = (4 laterals) x (13.5 gpm/lateral)
= 54 gpm

Step 8: Select proper pump. For this example, assume the dosing tank is located 75 ft from the network inlet, the difference in elevation between the pump and the inverts of the distribution laterals is 7 ft, and a 3-in. diameter delivery pipe is to be used.

Friction loss in 3-in. pipe at 54 gpm (from Table 7-14)

$$= 0.58 + \frac{4}{10} (0.81 - 0.58)$$

$$= 0.67 \text{ ft/100 ft}$$

Friction loss in 75 ft

$$= (0.67 \text{ ft/100 ft}) \times (75 \text{ ft})$$

$$= 0.5 \text{ ft}$$

Elevation head = 7.0 ft

Pressure to be maintained = 2.0 ft

Total pumping head = 9.5 ft

Therefore, a pump capable of delivering at least 54 gpm against 9.5 ft of head is required.

In summary, the final network design consists of four 32-ft laterals 1-1/4 in. in diameter (two on each side of a 3-in. diameter center manifold). The inverts of the laterals are perforated with 1/4-in. holes spaced every 30 in.

g. Other Distribution Networks

Several other distribution network designs are occasionally used. Among these are the inverted network and leaching chambers. While users of these networks claim they are superior to conventional networks, comprehensive evaluations of their performance have not been made.

Inverted Network: This network uses perforated pipe with the holes located in the crown rather than near the invert (32). This arrangement is designed to provide more uniform distribution of wastewater over a large area, and to prolong the life of the field by collecting any settleable solids passing out of the septic tank in the bottom of the pipe. Water-tight sumps are located at both ends of each inverted line to facilitate periodic removal of the accumulated solids.

Leaching Chambers: In place of perforated pipe and gravel for distribution and storage of the wastewater, this method employs open bottom chambers. The chambers interlock to form an underground cavern over the soils' infiltrative surface. The wastewater is discharged into the cavern through a central weir, trough, or splash plate and allowed to flow over the infiltrative surface in any direction. Access holes in the roof of the chamber allow visual inspection of the soil surface and maintenance as necessary. A large number of these systems have been installed in the northeastern United States (see Figure 7-33).

7.2.8.2 Materials

Three to 4-in. (8- to 10-cm) diameter pipe or tile is typically used for nonpressurized networks. Either perforated pipe or 1-ft (30 cm) lengths of suitable drain tile may be used. The perforated pipe commonly has one or more rows of 3/8- to 3/4-in. (1.0- to 2.0-cm) diameter holes. Hole spacing is not critical. Table 7-15 can be used as a guide for acceptable materials for nonpressurized networks.

Plastic pipe is used for pressure distribution networks because of the ease of drilling and assembly. Either PVC Schedule 40 (ASTM D 2665) or ABS (ASTM 2661) pipe may be used.

TABLE 7-15
PIPE MATERIALS FOR NONPRESSURIZED DISTRIBUTION NETWORKS

| <u>Type of Material</u> | <u>Specification</u> | <u>Class</u> |
|---|---|------------------------|
| Clay Drain Tile | ASTM C-4 | Standard Drain Tile |
| Clay Pipe Standard and Extra- Strength Perforated | ASTM C-211 | Standard |
| Bituminized Fiber Pipe Homogeneous Perforated | ASTM D-2312 | |
| Laminated-Wall Perforated | ASTM D-2313 | |
| Concrete Pipe Perforated Concrete | ASTM C-44 (Type 1 or Type 2) | ASTM C-14 ^a |
| Plastic Acrylonitrile- Butadiene- Styrene (ABS) | ASTM D-2751 ^b | |
| Polyvinyl Chloride (PVC) | ASTM D-2729 ^b D-3033 ^b D-3034 ^b | |
| Styrene-Rubber Plastic (SR) | ASTM D-2852 ^b D-3298 ^b | |
| Polyethylene (PE) o Straight Wall o Corrugated (Flexible) | ASTM D-1248 ^b ASTM F-405-76 ^b | |

^a Must be of quality to withstand sulfuric acid.

^b These specifications are material specifications only. They do not give the location or shape of perforations.

FIGURE 7-33
SCHEMATIC OF A LEACHING CHAMBER

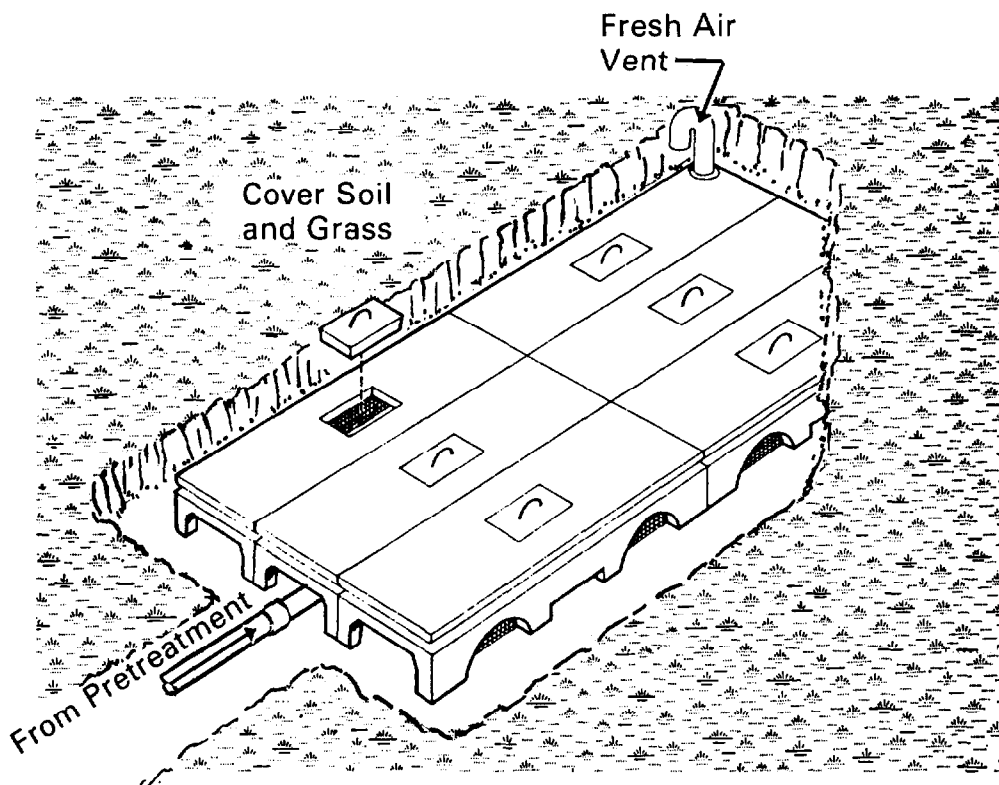

7.2.8.3 Construction

a. Gravity Network Pipe Placement

To insure a free flow of wastewater, the distribution pipe should be laid level or on a grade of 1 in. to 2 in. per 100 ft (8.5 to 16.9 cm/100 m). To maintain a level or uniform slope, several construction techniques can be employed. In each case a tripod level or transit is used to obtain the proper grade elevations. Hand levels are not adequate.

The rock is placed in the excavation to the elevation of the pipe invert. The rock must be leveled by hand to establish the proper grade. Once the pipe is laid, more rock is carefully placed over the top of the pipe. Care must also be taken when flexible corrugated plastic pipe is used, because the pipe tends to "float" up as rock is placed over the top of the pipe. One method is to employ special holders which can be removed once all the rock is in place (see Figure 7-34).

FIGURE 7-34

USE OF METAL HOLDERS FOR THE
LAYING OF FLEXIBLE PLASTIC PIPE

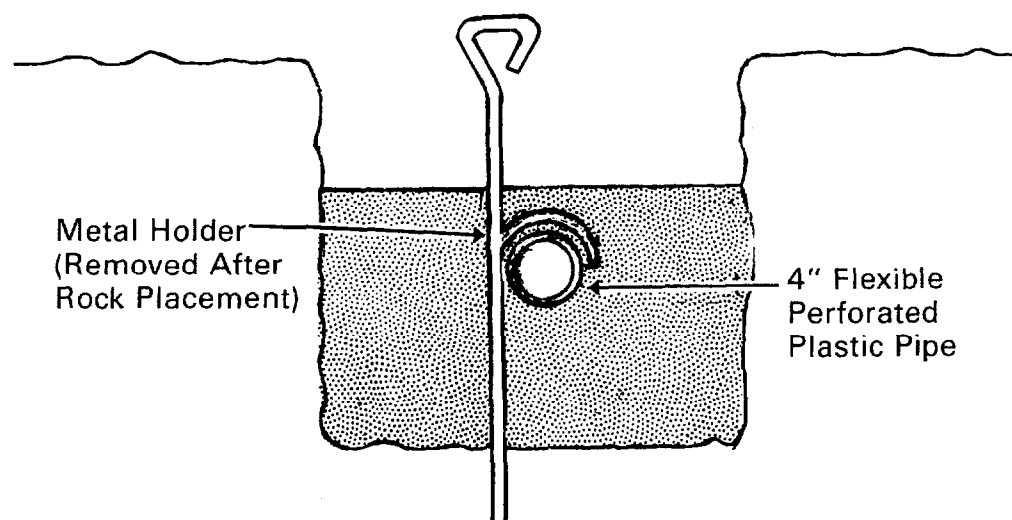

b. Pressure Network Pipe Placement

Pressure distribution networks are usually fabricated at the construction site. This may include drilling holes in distribution laterals. The holes must be drilled on a straight line along the length of the pipe. This can be accomplished best by using 1-in. by 1-in. angle iron as a straight-edge to mark the pipe. The holes are then drilled at the proper spacing. Care must be used to drill the holes perpendicular to the pipe and not at an angle. All burrs left around the holes inside the pipe should be removed. This can be done by sliding a smaller diameter pipe or rod down the pipe to knock the burrs off.

Solvent weld joints are used to assemble the network. The laterals are attached to the manifold such that the perforations lie at the bottom of the pipe.

Since the network is pressurized, small elevation differences along the length of the lateral do not affect the uniform distribution significantly. However, these variations should be held within 2 to 3 in. (5 to 8 cm). The rock is placed in the absorption area first, to the elevation of the distribution laterals. The rock should be leveled by hand, maintaining the same elevation throughout the system, before laying the pipe. After the pipe is laid, additional rock is placed over the pipe.

c. Distribution Boxes

If used, distribution boxes should be installed level and placed in an area where the soil is stable and remains reasonably dry. To protect the box from frost heaving, a 6-in. (15-cm) layer of 1/2- to 2-1/2-in. (1.2- to 6.4-cm) rock should be placed below and around the sides of the box. Solid wall pipe should be used to connect the box with the distribution laterals. Separate connections should be made for each lateral. To insure a more equal division of flow, the slope of each connecting pipe should be identical for at least 5 to 10 ft (1.3 to 3.0 m) beyond the box.

7.3 Evaporation Systems

7.3.1 Introduction

Two basic types of onsite evaporation systems are in use today:

1. Evapotranspiration beds (with and without infiltration)
2. Lagoons (with and without infiltration)

The advantages of these systems are that they utilize the natural energy of the sun and, optionally, the natural purification capabilities of soil to dispose of the wastewater. They must, however, be located in favorable climates. In some water-short areas where consumptive water use is forbidden (e.g., Colorado), they may not be allowed.

Mechanical evaporators are in the experimental stage, and are not commercially available. For this reason, they are not included in this discussion.

7.3.2 Evapotranspiration and Evapotranspiration/Absorption Beds

7.3.2.1 Introduction

Evapotranspiration (ET) beds can be used to dispose of wastewater to the atmosphere so that no discharge to surface or groundwater is required. Evapotranspiration/absorption (ETA) is a modification of the ET concept in which discharges to both the atmosphere and to the groundwater are incorporated. Both ET and ETA have been utilized for onsite wastewater disposal to the extent that several thousand of these systems are in use in the United States (33).

7.3.2.2 Description

Onsite ET disposal normally consists of a sand bed with an impermeable liner and wastewater distribution piping (see Figure 7-35). The surface of the sand bed may be planted with vegetation. Wastewater entering the bed is normally pretreated to remove settleable and floatable solids. An ET bed functions by raising the wastewater to the upper portion of the bed by capillary action in the sand, and then evaporating it to the atmosphere. In addition, vegetation transports water from the root zone to the leaves, where it is transpired. In ETA systems, the impervious liner is omitted, and a portion of the wastewater is disposed of by seepage into the soil.

Various theoretical approaches are used to describe the evaporation process. This suggests that there may be some uncertainty associated with a precise quantitative description of the process. However, current practice is to limit the uncertainties by basing designs on a correlation between available pan evaporation data and observed ET rates, thereby minimizing assumptions and eliminating the need to average long-term climatic data. References (33)(34)(35) and (36) provide a more detailed discussion of the correlation method.

7.3.2.3 Application

Onsite systems utilizing ET disposal are primarily used where geological limitations prevent the use of subsurface disposal, and where discharge to surface waters is not permitted or feasible. The geological conditions that tend to favor the use of ET systems include very shallow soil mantle, high groundwater, relatively impermeable soils, or fractured bedrock. ETA systems are generally used where slowly permeable soils are encountered.

FIGURE 7-35

CROSS SECTION OF TYPICAL ET BED

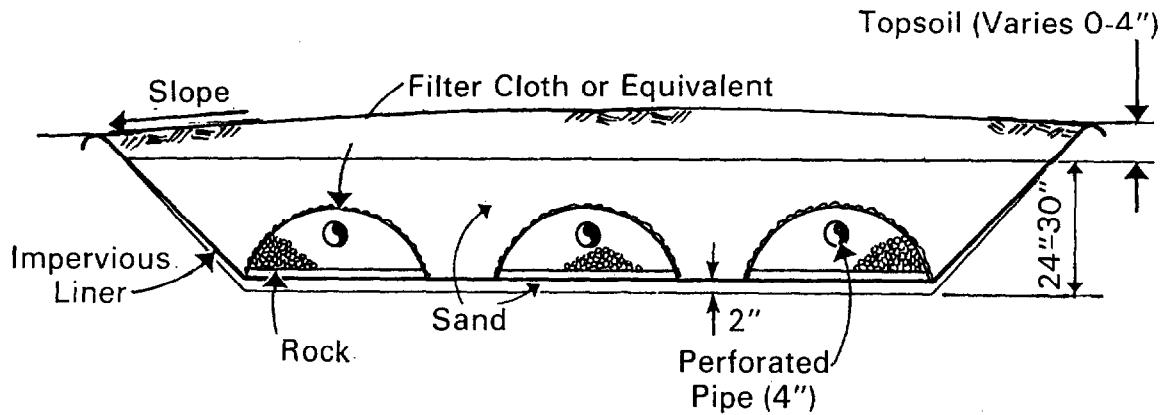

Although ET systems may be used where the application of subsurface disposal systems is limited, they are not without limitations. As with other disposal methods that require area-intensive construction, the use of ET systems can be constrained by limited land availability and site topography. Based on experience to date with ET disposal for year-round single-family homes, approximately 4,000 to 6,000 ft² (370 to 560 m²) of available land is typically required. The maximum slope at which an ET system is applicable has not been established, but use on slopes greater than 15% may be possible if terracing, serial distribution, and other appropriate design features are incorporated.

By far the most significant constraint on the use of ET systems is climatic conditions. The evaporation rate is controlled primarily by climatic factors such as precipitation, wind speed, humidity, solar radiation, and temperature. Recent studies indicate that essentially all of the precipitation that falls on an ET bed infiltrates into the bed and becomes part of the hydraulic load that requires evaporation (33)(34) (37). Provisions for long-term storage of effluent and precipitation in ET systems during periods of negative net evaporation, and for subsequent evaporation during periods of positive net evaporation, are expensive. Thus, the year-around use of nondischarging ET systems appears to be feasible only in the arid and semiarid portions of the western and southwestern United States where evaporation exceeds precipitation during every month of operation, so that long-term storage capacity is not

required. ET systems for summer homes may be feasible in the more temperate parts of the country. For ETA systems, the range of applicability is less well defined, but the soils must be capable of accepting all of the influent wastewater if net evaporation is zero for any significant periods of the year.

In addition to climate and site conditions, the characteristics of wastewater discharged to an onsite disposal system may affect its application. For ET disposal, pretreatment to remove settleable and floatable solids is necessary to prevent physical clogging of the wastewater distribution piping. The relative advantages of aerobic versus septic tank pretreatment for ET and ETA systems have been discussed in the literature (33)(35)(37)(38). Although each method has been supported by some researchers, reports of well-documented, controlled studies indicate that septic tank pretreatment is adequate (33)(34)(37).

7.3.2.4 Factors Affecting Performance

The following factors affect the performance of ET and ETA systems:

1. Climate
2. Hydraulic loading
3. Sand capillary rise characteristics
4. Depth of free water surface in the bed
5. Cover soil and vegetation
6. Construction techniques
7. Salt accumulation (ET only)
8. Soil permeability (ETA only)

As noted previously, climate has a significant effect on the application and performance of ET and ETA systems. Solar radiation, temperature, humidity, wind speed, and precipitation all influence performance. Since these parameters fluctuate from day to day, season to season, and year to year, evaporation rates also vary substantially. To insure adequate overall performance, these fluctuations must be considered in the design.

The hydraulic loading rate of an ET bed affects performance. Too high a loading rate results in discharge from the bed; too low a loading rate results in a lower gravity (standing) water level in the bed and inefficient utilization. Several researchers noted decreased evaporation rates with decreased water levels (33)(34)(35). This problem can be overcome by sectional construction in level areas to maximize the water level in a portion of the bed, and by serial distribution for sloping sites.

The capillary rise characteristic of the sand used to fill the ET bed is important since this mechanism is responsible for transporting the water to the surface of the bed. Thus, the sand needs to have a capillary rise potential at least as great as the depth of the bed, and yet should not be so fine that it becomes clogged by solids in the applied wastewater (33).

Significant seasonal fluctuations in the free water surface are normal, necessitating the use of vegetation that is tolerant to moisture extremes. A variety of vegetation, including grasses, alfalfa, broad-leaf trees, and evergreens, have been reported to increase the average annual evaporation rate from an ET bed to above that for bare soil (35). However, grasses and alfalfa also result in nearly identical or reduced evaporation rates as compared to bare soil in the winter and the spring when evaporation rates are normally at a minimum (33)(34). Similarly, top soil has been reported to reduce evaporation rates. Certain evergreen shrubs, on the other hand, have been shown to produce slightly greater evaporation rates than bare soil throughout the year (33). Thus, there are conflicting views on the benefits of cover soil and vegetation.

Although ET system performance is generally affected less by construction techniques than most subsurface disposal methods, some aspects of ET construction can affect performance. Insuring the integrity of the impermeable liner and selecting the sand to provide for maximum capillary rise properties are typically the most important considerations. For ETA systems, the effects of construction techniques are similar to those discussed previously with reference to subsurface disposal systems in slowly permeable soils.

Salt accumulation in ET disposal systems occurs as wastewater is evaporated. Salt accumulation is particularly pronounced at the surface of the bed during dry periods, although it is redistributed throughout the bed by rainfall. Experience to date indicates that salt accumulation does not interfere with the operation of nonvegetated ET systems (39) (40). For ET systems with surface vegetation, salt accumulation may adversely affect performance after a long period of use, although observations of ET systems that have been in operation for 5 years indicate no significant problems (33). In order to minimize potential future problems associated with salt accumulation, the ET or ETA piping system may be designed to permit flushing of the bed.

Since ETA systems utilize seepage into the soil as well as evaporation for wastewater disposal, soil permeability is also a factor in the performance of these systems. Discussion of this factor relative to subsurface disposal systems (Section 7.2) applies here.

Data that quantitatively describe performance are not available for ET or ETA disposal. However, the technical feasibility of nondischarging ET disposal has been demonstrated under experimental conditions (33) (34). In addition, observations of functioning ET systems indicate that adequate performance can be achieved at least in semiarid and arid areas. The performance of ETA systems depends primarily on the relationship between climate and soil characteristics, and has not been quantified. However, the technical feasibility of such systems is well accepted.

7.3.2.5 Design

ET and ETA systems must be designed so that they are acceptable in performance and operation. Requirements for acceptability vary. On one hand, acceptable performance can be defined for an ET system as zero discharge for a specified duration such as 10 years, based on the weather data for a similar period. Alternatively, occasional seepage or surface overflow during periods of heavy rainfall or snowmelt may be allowed. In addition, physical appearance requirements for specific types of vegetation and/or a firm bed surface for normal yard use (necessitating a maximum gravity water level approximately 10 in. [25 cm] below the surface) may also be incorporated in the criteria.

Appropriate acceptance criteria vary with location. For example, occasional discharge may be acceptable in low-density rural areas, whereas completely nondischarging systems are more appropriate in higher density suburban areas. Thus, acceptance criteria are usually defined by local health officials to reflect local conditions (33).

Since the size (and thus the cost) of ET and ETA systems are dependent on the design hydraulic loading rate, any reduction in flow to those systems is beneficial. Therefore, flow reduction devices and techniques should be considered an integral part of an ET or ETA system.

The design hydraulic loading rate is the principal design feature affected by the acceptance criteria. Where a total evaporation system is required, the loading rate must be low enough to prevent the bed from filling completely. Some discrepancy in acceptable loading rates has been reported. Although reports of system designs based on higher loading rates have been presented in the literature (35)(37), other data obtained under controlled conditions indicate that pan evaporation must exceed precipitation in all months of a wet year (based on at least 10 years of data) if a total, year-round evaporation system is used. Under these conditions, loading rates between 0.03 and 0.08 gpd/ft² (1.2 and 3.3 l/m²/day) were found to be appropriate in western states (Colorado and Arizona) (33)(34).

The hydraulic loading rate is determined by an analysis of the monthly net ET ([pan evaporation x a local factor] minus precipitation) experienced in the wettest year of a 10-year period. Ten years of data should be analyzed, as very infrequent but large precipitation events may be experienced over the life of the system that would result in very infrequent discharge. Where occasional discharge from an ET system is acceptable, loading rates may be determined on a less restrictive basis, such as minimum monthly net ET in a dry year. If the unit is used for seasonal application, then only those months of occupancy will constitute the basis for design.

The loading rate for ETA systems is determined in the same manner, except that an additional factor to account for seepage in the soil is included. Thus, the loading rate for an ETA system is generally greater than the loading rate for an ET system in the same climate. The available data indicate that ETA systems can be used with a wider range of climatic conditions. For example, if soil can accept 0.2 gpd/ft² (8.1 l/m²/day), and the minimum monthly net ET is zero (determined as necessary according to the acceptance criteria), the loading rate for design is also 0.2 gpd/ft² (8.1 l/m²/day).

In addition to loading rates, the designer must also consider selection of fill material, cover soil, and vegetation. The role of vegetation in providing additional transpiration for ET systems is uncertain at this time. During the growing season, the impact of vegetation could be significant. However, during the nongrowing season, the effect of vegetation has not been well documented. Sand available for ET and ETA bed construction should be tested for capillary rise height and rate before one is selected. In general, clean and uniform sand in the size of D₅₀ = 0.1 mm (50% by weight smaller than or equal to 0.1 mm) is desirable (33).

The assumptions for a sample ET bed design are given below:

1. Four occupants of home
2. 45-gpcd design flow (no in-home water reduction)
3. Location: Boulder, Colorado
4. Critical months: December 1976 (see Figure 7-36)
5. Precipitation: 0.01 in./day (0.25 mm/day)
6. Pan evaporation: 0.07 in./day (1.7 mm/day)

An ET bed must be able to evaporate the household wastewater discharged to it as well as any rain that falls on the bed surface. Thus, the design of an ET system is based on the estimated flow from the home and the difference between the precipitation rate and the evaporation rate

FIGURE 7-36

CURVE FOR ESTABLISHING PERMANENT HOME LOADING RATE FOR BOULDER, COLORADO
BASED ON WINTER DATA, 1976-1977(33)

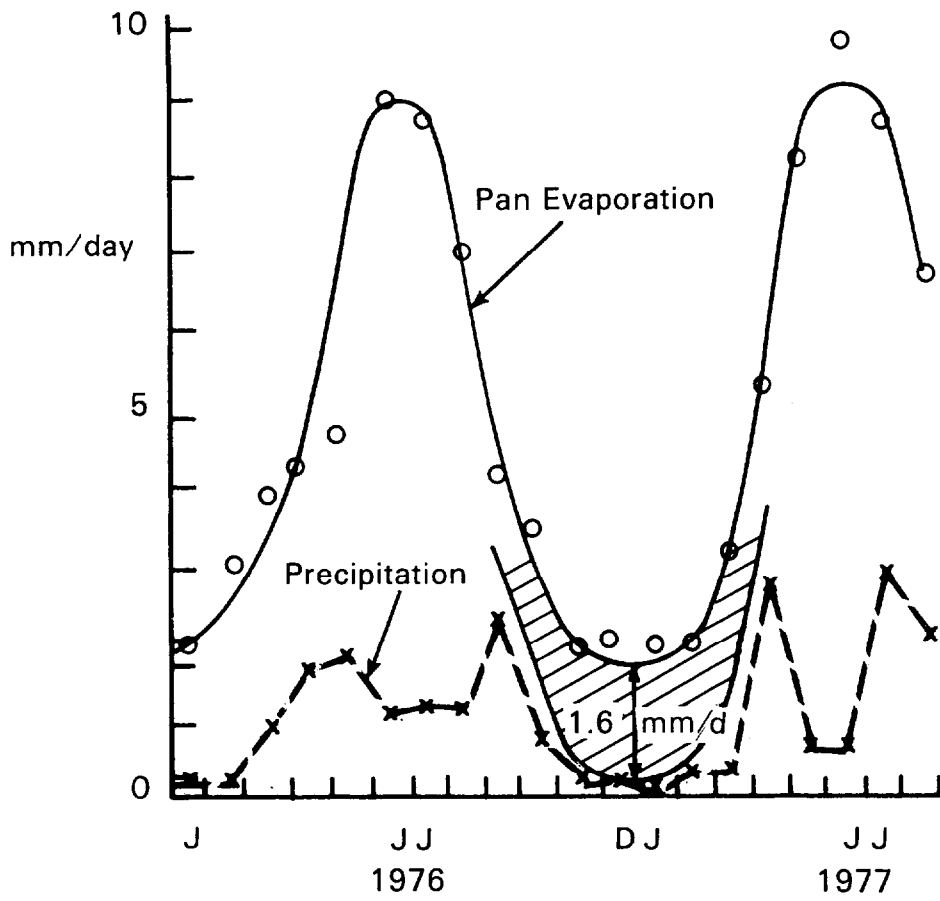

during the critical months of the year. In this example, we are assuming an average household flow of 4 persons x 45 gcpd, or 180 gpd total. Past work has shown that actual evaporation from an ET system is approximately the same as the measured pan evaporation rate in winter (33). Summer rates are approximately 70% of the measured pan evaporation rates in this area, but excessive evaporation potential more than offsets this condition. Therefore, the design is based on pan evaporation (in./day) minus precipitation (in./day). In this example,

$$(0.07 \text{ in./day}) - (0.01 \text{ in./day}) = 0.06 \text{ in./day}$$

This equates to a rate of 0.04 gpd/ft².

In this example, then, the required area for the ET bed is finally calculated:

$$\frac{180 \text{ gpd}}{0.04 \text{ gpd/ft}^2} = 4,500 \text{ ft}^2$$

To allow a factor of safety, the size could be increased to as much as 7,500 ft² based on 75 gpcd. A more realistic size would be 5,000 to 6,000 ft², which would insure no overflows. If water conservation is practiced, direct significant savings in size and costs could be achieved.

7.3.2.6 Construction Features

A typical ET bed installation was shown previously in Figure 7-35. Characteristics of an ETA bed are identical except that the liner is omitted. Limited data are available on optimum construction features for ET and ETA disposal units. The following construction features are desirable:

1. Synthetic liners should have a thickness of at least 10 mil; it may be preferable to use a double thickness of liner material so that the seams can be staggered if seams are unavoidable.
2. Synthetic liners should be cushioned on both sides with layers of sand at least 2 in. (5 cm) thick to prevent puncturing during construction.
3. Surface runoff from adjacent areas should be diverted around the system by berms or drainage swales.

4. Crushed stone or gravel placed around the distribution pipes should be 3/4 to 2-1/2 in. (2 to 6 cm).
5. Filter cloth or equivalent should be used on top of the rock or gravel to prevent sand from settling into the aggregate, thus reducing the void capacity.
6. Care should be exercised in assembling the perforated distribution pipes (4 in. [10 cm]) to prevent pipe glues and solvents from contacting the synthetic liner.
7. The bed surface should be sloped for positive drainage.
8. A relatively porous topsoil, such as loamy sand or sandy loam, should be used if required to support vegetation to prevent erosion, or to make the appearance more acceptable.
9. The bed should be located in conformance with local code requirements.
10. Construction techniques described previously for subsurface disposal systems, where soil permeability may be decreased by poor construction practices, should be used for ETA systems (39)(40)(41).

7.3.2.7 Operation and Maintenance

Routine operation and maintenance of an ET or ETA disposal unit consists only of typical yard maintenance activities such as vegetation trimming. Pretreatment units and appurtenances require maintenance as described in Chapter 8. Unscheduled maintenance requirements are rare, and stem mainly from poor operating practices such as failure to pump out septic tank solids.

7.3.2.8 Considerations for Multi-Home and Commercial Wastewaters

ET systems may be applicable to small housing clusters and commercial/institutional establishments, but large area requirements may limit their practicality. Adjustments in the type of pretreatment used may be required depending on the wastewater characteristics. For example, a grease trap is normally required prior to septic tank or aerobic treatment of restaurant wastewater disposed of in an ET system.

7.3.3 Evaporation and Evaporation/Infiltration Lagoons

7.3.3.1 Description

Lagoons have found widespread application for treatment of municipal wastewater from small communities, and have occasionally been used for wastewater treatment in onsite systems prior to discharge to surface waters. A more common application in onsite systems has been for treatment and subsequent disposal by evaporation, or a combination of evaporation and infiltration.

A discussion of evaporation and evaporation/infiltration lagoons is provided, since thousands are currently in use across the United States. However, performance data are very limited. The information provided in this section is based on current practice without assurance that such practice is optimal.

7.3.3.2 Application

In the United States, an evaporation or evaporation/infiltration lagoon could be used in most locations that have enough available land. However, local authorities typically prefer or require the use of subsurface disposal systems where conditions permit. Thus, actual application of these lagoons is generally limited to rural areas where subsurface disposal is not possible. In addition, use of evaporation/infiltration lagoons is not appropriate in areas where wastewater percolation might contaminate groundwater supplies, such as in areas of shallow or creviced bedrock, or high water tables. Use of both types of lagoons, especially evaporation lagoons, is favored by the large net evaporation potentials found in arid regions.

Data on the impact of influent wastewater characteristics on evaporation and evaporation/infiltration lagoons are very limited. Pretreatment is desirable, especially if a garbage grinder discharges to the system.

7.3.3.3 Factors Affecting Performance

The major climatic factors affecting performance of evaporation and evaporation/infiltration lagoons include sunlight, wind circulation,

humidity, and the resulting net evaporation potential. Other features that affect performance include:

1. Soil permeability (evaporation/infiltration only)--lagoon size and soil permeability are inversely proportional
2. Salt accumulation (evaporation only)--results in decreased evaporation rate
3. Hydraulic loading--size must accommodate peak flows
4. Inlet configuration--center inlet tends to improve mixing and minimize odors
5. Construction techniques

7.3.3.4 Design

Lagoons can be circular or rectangular. The maximum wastewater depth is normally 3 to 5 ft (0.9 to 1.5 m) with a freeboard of 2 or 3 ft, (0.6 to 0.9 m), although depths greater than 8 ft (2.4 m) have also been used (42)(43)(44)(45)(46)(47). The minimum wastewater depth is generally 2 ft (0.6 m). This may necessitate the addition of fresh water during high-evaporation summer months. Figure 7-37 shows the dimensional requirements for a typical onsite lagoon. The size ranges from 3 to 24 ft²/gpcd (0.07 to 0.57 m²/lpcd), depending primarily on the type of lagoon (evaporation or evaporation/infiltration), soil permeability, climate, and local regulations.

Lagoon design is usually based on locally available evaporation and precipitation data, soil percolation rates (evaporation/infiltration only), and an assumed wastewater flow. Since runoff is excluded by the containment berms, evaporation lagoons need only provide adequate surface area to evaporate the incident precipitation and the influent wastewater. Calculations may be made initially on an annual basis, but must then be checked to insure that adequate volume is provided for storage during periods when liquid inputs exceed evaporation. A brief design example is outlined below.

Assumptions:

1. Four occupants of home
2. 45-gpcd wastewater flow
3. Annual precipitation: 15.3 in.
4. Annual evaporation: 46.7 in.

FIGURE 7-37

TYPICAL EVAPORATION/INFILTRATION LAGOON FOR SMALL INSTALLATIONS

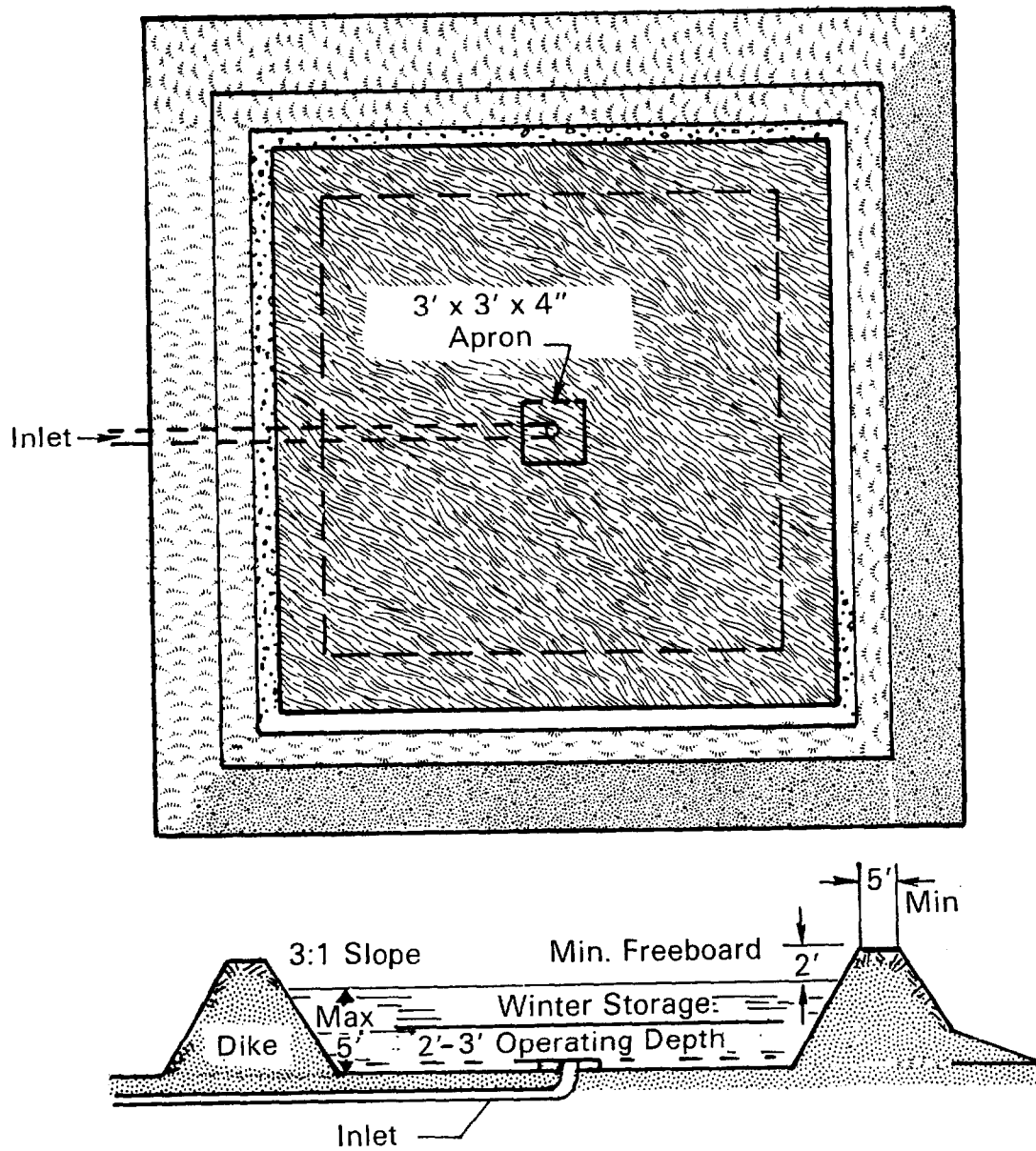

Design flow:

$$4 \text{ persons} \times 45 \text{ gpcd} = 180 \text{ gpd}$$

Net evaporation per year:

$$46.7 \text{ in.} - 15.3 \text{ in.} = 31.4 \text{ in.}$$

$$(31.4 \text{ in.})(144 \text{ in.}^2) = 4,522 \text{ in.}^3 \text{ of water/ft}^2 \text{ water surface}$$

$$(4,522 \text{ in.}^3)(\text{ft}^3/1,728 \text{ in.}^3)(7.48 \text{ gal/ft}^3) = 19.6 \text{ gal of water/ft}^2 \text{ water surface}$$

Lagoon area required:

$$(180 \text{ gpd})(365 \text{ days})/(19.6 \text{ gal/ft}^2) = 3,352 \text{ ft}^2$$

This can be provided by a round lagoon, 65.3-ft diameter.

At this point, we need to ensure that the lagoon will have adequate storage capacity to allow accumulation of water to a depth of no more than 4 or 5 ft in low-evaporation months (usually winter), and to allow sufficient surface area for evaporation of the accumulated water plus new influent flows during the months when evaporation rates exceed the monthly wastewater flow (usually summer). This is done by comparing the wastewater flow against the evaporation rate for each months, and by performing a water balance (i.e., calculating the gain or loss in gallons for each months). Table 7-16 shows such a balance.

From October through April, the lagoon will gain 35,443 gal of volume. This is equivalent to a gain of 1.4 ft:

$$(35,443 \text{ gal})\left(\frac{1}{3,352 \text{ ft}^2}\right)\left(\frac{\text{ft}^3}{7.48 \text{ gal}}\right) = 1.4 \text{ ft}$$

Beginning with a 2-ft minimum depth, the depth of the lagoon varies from 2 ft to 3.4 ft.

Some sources indicate that BOD loadings should also be considered in lagoon sizing for odor control. Loadings in the range of 0.25 to 0.8 #BOD/day/1,000 ft² (1.2 to 3.9 kg/day/1000 m²) have been recommended, but supporting data for onsite systems are not available (43)(45)(46). If infiltration is permitted and feasible considering local soils, the size of the lagoon can be reduced by the amount of water lost through percolation.

TABLE 7-16

SAMPLE WATER BALANCE FOR EVAPORATION LAGOON DESIGN

| Month | Influent gal | Precip. in. | Evap. in. | Precipitation ^a -Evaporation | | Net ^b Flow gal | Cum. Volume gal |
|-----------|-----------------|----------------|--------------|--|--------|---------------------------------|-----------------------|
| | | | | in. | gal | | |
| October | 5580 | 1.1 | 2.2 | -1.1 | - 2299 | 3281 | 3281 |
| November | 5400 | 1.4 | 1.8 | -0.4 | - 836 | 4564 | 7845 |
| December | 5580 | 1.8 | 1.7 | 0.1 | 209 | 5789 | 13634 |
| January | 5580 | 1.6 | 0.7 | 0.9 | 1881 | 7461 | 21095 |
| February | 5040 | 1.6 | 0.9 | 0.7 | 1463 | 6503 | 27598 |
| March | 5580 | 1.4 | 1.2 | 0.2 | 418 | 5998 | 33596 |
| April | 5400 | 1.4 | 3.1 | -1.7 | - 3553 | 1847 | 35443 |
| May | 5580 | 1.2 | 5.3 | -4.1 | - 8569 | - 2989 | 32454 |
| June | 5400 | 1.2 | 6.1 | -4.9 | -10241 | - 4841 | 27613 |
| July | 5580 | 0.8 | 9.4 | -8.6 | -17974 | -12394 | 15219 |
| August | 5580 | 0.8 | 9.0 | -8.2 | -17138 | -11558 | 3661 |
| September | 5400 | 1.0 | 5.3 | -4.3 | - 8987 | - 3587 | 74 |
| | <u>65700</u> | <u>15.3</u> | <u>46.7</u> | | | | |

$$\begin{aligned}
 \text{a } [\text{Precip.} - \text{Evap. (gal)}] &= [\text{Precip.} - \text{Evap. (in.)}] \times (3352 \text{ ft}^2) \times (7.48 \text{ gal/ft}^3) \times (1/12) \\
 &= 2090 \times [\text{Precip.} - \text{Evap. (in.)}]
 \end{aligned}$$

$$\text{b Net Flow} = (\text{Influent}) + (\text{Precip.} - \text{Evap.})$$

Other design features which are frequently incorporated include fencing, center inlet, specific berm slopes, and buffer zones. Five- or 6-ft (1.5- to 1.8-m) high fencing is preferred to limit animal and human intrusion. Submerged center inlets are recommended to facilitate mixing, to provide even solids deposition, and to minimize odors. Interior berm slopes, steep enough to minimize rooted aquatic plant growth in the lagoon, but resistant to erosion, are desirable. Slopes sufficient to accomplish this objective have been reported to be between 3:1 and 2:1, depending primarily on height and soil characteristics. Buffer zones are normally controlled by local regulations, but typically range from 100 to 300 ft (30 to 91 m).

7.3.3.5 Construction Features

To prevent seepage through the berm in unlined lagoons, a good interface between the berm and the native soil is necessary. In areas where the use of subsurface disposal systems is restricted due to slowly permeable soils, B-horizon soils are frequently appropriate for berm construction. Excavation of the topsoil prior to berm placement (so that the base of the berm rests on the less permeable subsoils) reduces the incidence of seepage, as does compaction of the berm material during placement. For evaporation lagoons, care during construction to insure placement of a leak-free liner reduces the need for impermeable berm material and associated construction precautions.

7.3.3.6 Operation and Maintenance

Start-up of a lagoon system requires filling the lagoon from a convenient freshwater source to a depth of at least 2 ft (0.6 m). This initial filling helps to prevent rooted plant growth and septic odors.

Solids removal is required periodically for evaporation lagoons. Data are not available to indicate the exact frequency of solids removal required, but intervals of several years between pump-outs can be anticipated.

The reported need for chemical addition to control odors, insects, rooted plants, and microbial growth varies on a case-by-case basis with climate, lagoon location and configuration, and loading rate. Maintenance of a minimum 2-ft (0.6-m) wastewater depth in the lagoon, and frequent trimming of vegetation on the berm and in the vicinity of the lagoon, are suggested. No other maintenance is required.

7.3.3.7 Seasonal, Multifamily, and Commercial Applications

Use of evaporation and evaporation/infiltration lagoons for summer homes would result in somewhat reduced area requirements per gallon of wastewater handled, since storage would not need to be provided during the winter months. Otherwise, application of these systems to seasonal dwellings is comparable to year-round residences.

Evaporation and evaporation/infiltration lagoons are also applicable to multifamily and commercial applications, although additional pretreatment may be required depending on the wastewater characteristics.

7.4 Outfall to Surface Waters

Direct discharge of onsite treatment system effluent is a disposal option if an appropriate receiving water is available and if the regulatory agencies permit such a discharge. The level of treatment required varies, depending on local regulations, stream water quality requirements, and other site-specific conditions. In general, onsite treatment system effluent disposed by surface discharge must at least meet secondary treatment standards for publicly owned treatment works. Depending on site-specific conditions, more stringent BOD and SS discharge requirements and/or limitations on N and P discharges may be applicable.

The performance, operation, and maintenance requirements, and the environmental acceptability of the surface discharge depend predominantly on the preceding treatment system. Operation and maintenance associated specifically with the surface discharge pipe are minimal in a gravity situation. If the effluent must be pumped, then routine pump maintenance will be required.

Discharge pipes should be made of corrosion- and crush-resistant materials such as cast iron or rigid plastic pipe. For single-family systems, the pipe should range from 2 to 4 in. (5 to 10 cm) in diameter, should be buried, and should be moderately sloped (between 0.5 and 3%). Steep slopes may cause washout at the discharge point.

7.5 References

1. Bendixen, T. W., M. Berk, J. P. Sheehy, and S. R. Weibel. Studies on Household Sewage Disposal Systems, Part II. NTIS Report No. PB 216 128, Environmental Health Center, Cincinnati, Ohio, 1950. 96 pp.

2. Bouma, J. Unsaturated Flow During Soil Treatment of Septic Tank Effluent. *J. Environ. Eng. Div., Am. Soc. Civil Eng.*, 101:996-983, 1975.
3. Manual of Septic Tank Practice. Publication No. 526, Public Health Service, Washington, D.C., 1967. 92 pp.
4. Small Scale Waste Management Project, University of Wisconsin, Madison. Management of Small Waste Flows. EPA 600/2-78-173, NTIS Report No. PB 286 560, September 1978. 804 pp.
5. Laak, R. Pollutant Loads From Plumbing Fixtures and Pretreatment to Control Soil Clogging. *J. Environ. Health*, 39:48-50, 1976.
6. Winneberger, J. H., L. Francis, S. A. Klein, and P. H. McGauhey. Biological Aspects of Failure of Septic Tank Percolation Systems; Final Report. Sanitary Engineering Research Laboratory, University of California, Berkeley, 1960.
7. Winneberger, J. T., and J. W. Klock. Current and Recommended Practices for Subsurface Waste Water Disposal Systems in Arizona. Engineering Research Center Report No. ERC-R-73014, College of Engineering Service, Arizona State University, Tempe, 1973.
8. Subsurface Wastewater Disposal Regulations. Plumbing Code, Part II. Department of Human Services, Division of Health Engineering, Augusta, Maine, 1978.
9. Weibel, S. R., T. W. Bendixen, and J. B. Coulter. Studies on Household Sewage Disposal Systems, Part III. NTIS Report No. PB 217 415, Environmental Health Center, Cincinnati, Ohio, 1954. 150 pp.
10. Corey, R. B., E. J. Tyler, and M. V. Olotu. Effects of Water Softener Use on the Permeability of Septic Tank Seepage Fields. In: Proceedings of the Second National Home Sewage Treatment Symposium, Chicago, Illinois, December 1977. American Society of Agricultural Engineers, St. Joseph, Michigan, 1978. pp. 226-235.
11. Machmeier, R. E. Town and Country Sewage Treatment. Bulletin 304, University of Minnesota, St. Paul, Agricultural Extension Service, 1979.
12. Otis, R. J., G. D. Plews, and D. H. Patterson. Design of Conventional Soil Absorption Trenches and Beds. In: Proceedings of the Second National Home Sewage Treatment Symposium, Chicago, Illinois, December 1977. American Society of Agricultural Engineers, St. Joseph, Michigan, 1978. pp. 86-99.

13. McGauhey, P. H., and J. T. Winneberger. Final Report on a Study of Methods of Preventing Failure of Septic Tank Percolation Systems. SERL Report No. 65-17, Sanitary Engineering Research Laboratory, University of California, Berkeley, 1965. 33 pp.
14. Bendixen, T. W., J. B. Coulter, and G. M. Edwards. Study of Seepage Beds. Robert A. Taft Sanitary Engineering Center, Cincinnati, Ohio, 1960.
15. Bouma, J., J. C. Converse, and F. R. Magdoff. Dosing and Resting to Improve Soil Absorption Beds. Trans. Am. Soc. Civ. Eng., 17:295-298, 1974.
16. Harkin, J. M., and M. D. Jawson. Clogging and Unclogging of Septic System Seepage Beds. In: Proceedings of the Second Illinois Private Sewage Disposal System, Champaign, Illinois, 1977. Illinois Department of Public Health, Springfield. pp. 11-21.
17. Otis, R. J., J. C. Converse, B. L. Carlile, and J. E. Witty. Effluent Distribution. In: Proceedings of the Second National Home Sewage Treatment Symposium, Chicago, Illinois, December 1977. American Society of Agricultural Engineers, St. Joseph, Michigan, 1978. pp. 61-85.
18. Kropf, F. W., R. Laak, and K. A. Healey. Equilibrium Operation of Subsurface Absorption Systems. J. Water Pollut. Control Fed., 49:2007-2016, 1977.
19. Otis, R. J. An Alternative Public Wastewater Facility for a Small Rural Community. Small Scale Waste Management Project, University of Wisconsin, Madison, 1978.
20. Alternatives for Small Wastewater Treatment Systems. EPA 625/4-77-011, NTIS Report No. PB 299 608, Center for Environmental Research Information, Cincinnati, Ohio, 1977.
21. Bendixen, T. W., R. E. Thomas, and J. B. Coulter. Report of a Study to Develop Practical Design Criteria for Seepage Pits as a Method for Disposal of Septic Tank Effluents. NTIS Report No. PB 216 931, Cincinnati, Ohio, 1963. 252 pp.
22. Winneberger, J. T. Sewage Disposal System for the Rio-Bravo Tennis Ranch, Kern County, California. 1975.
23. Witz, R. L., G. L. Pratt, S. Vogel, and C. W. Moilanen. Waste Disposal Systems for Rural Homes. Circular No. AE 43, North Dakota State University Cooperative Extension Service, Fargo, 1974.
24. Converse, J. C., B. L. Carlile, and G. W. Peterson. Mounds for the Treatment and Disposal of Septic Tank Effluent. In: Proceedings of the Second National Home Sewage Treatment Symposium, Chicago,

- Illinois, December 1977. American Society of Agricultural Engineers, St. Joseph, Michigan, 1978. pp. 100-120.
25. Converse, J. C. Design and Construction Manual for Wisconsin Mounds. Small Scale Waste Management Project, University of Wisconsin, Madison, 1978. 80 pp.
 26. Soil Conservation Service. Drainage of Agricultural Land. Water Information Center, Port Washington, New York, 1973. 430 pp.
 27. Mellen, W. L. Identification of Soils as a Tool for the Design of Individual Sewage Disposal Systems. Lake County Health Department, Waukegan, Illinois, 1976. 67 pp.
 28. Casagrande, L. Electro-Osmotic Stabilization of Soils. J. Boston Soc. Civ. Eng., 39:51-82, 1952.
 29. On-Site Wastewater Management. National Environmental Health Association, Denver, Colorado, 1979. 108 pp.
 30. Electro-Osmosis, Inc., Minneapolis, Minnesota.
 31. Bendixen, T. W., and J. B. Coulter. Effectiveness at the Distribution Box. U.S. Public Health Service, Washington, D.C., 1958.
 32. Sheldon, W. H. Septic Tank Drainage Systems. Research Report No. 10, Farm Science Agricultural Experiment Station, Michigan State University, East Lansing, 1964.
 33. Bennett, E. R. and K. D. Linstedt. Sewage Disposal by Evaporation-Transpiration. EPA 600/2-78-163, NTIS Report NO. PB 288 588, September 1978. 196 pp.
 34. Rugen, M. A., D. A. Lewis, and I. J. Benedict. Evaporation - A Method of Disposing of Septic Tank Effluent. Edwards Underground Water District, San Antonio, Texas, (no date). 83 pp.
 35. Bernhardt, A. P. Treatment and Disposal of Wastewater from Homes by Soil Infiltration and Evapotranspiration. University of Toronto Press, Toronto, Canada, 1973. 173 pp.
 36. Pence, H. J. Evaluation of Evapotranspiration as a Disposal System for Individual Household Wastes (A Seven-State Test); Draft Report. National Science Foundation, Washington, D.C., 1979.
 37. Lomax, K. M., P. N. Winn, M. C. Tatro, and L. S. Lane. Evapotranspiration Method of Wastewater disposal. UMCEES Ref. No. 78-40, University of Maryland Center for Environmental and Estuarine Studies, Cambridge, 1978. 42 pp.

38. Bernhart, A. P. Return of Effluent Nutrients to the Natural Cycle Through Evapotranspiration and Subsoil-Infiltration of Domestic Wastewater. In: Proceedings of the National Home Sewage Disposal Symposium, Chicago, Illinois, December 1974. American Society of Agricultural Engineers, St. Joseph, Michigan, 1975. pp. 175-181.
39. Land Treatment of Municipal Wastewater Effluents. EPA 625/4-76-010, NTIS Report No. PB 259 994, Center for Environmental Research Information, Cincinnati, Ohio, 1976.
40. Jensen, M. E., H. G. Collins, R. D. Burman, A. E. Cribbs, and A. I. Johnson. Consumptive Use of Water and Irrigation Water Requirements. Irrigation Drainage Division, American Society of Civil Engineers, New York, 1974. 215 pp.
41. Priestly, C. H. B., and R. J. Taylor. On the Assessment of Surface Heat Flux and Evaporation Using Large-Scale Parameters. Mon. Weather Rev., 100:81-82, 1972.
42. Witz, R. L. Twenty-Five Years with the Nodak Waste Disposal System. In: Proceedings of the National Home Sewage Disposal Symposium, Chicago, Illinois, December 1974. American Society of Agricultural Engineers, St. Joseph, Michigan, 1975. pp. 168-174.
43. Standards for Designing a Stabilization Lagoon. North Dakota State Department of Health, Bismarck, (No date). 3 pp.
44. Pickett, E. M. Evapotranspiration and Individual Lagoons. In: Proceedings of Northwest Onsite Wastewater Disposal Short Course, University of Washington, Seattle, December 1976. pp. 108-118.
45. Standards for Subsurface and Alternative Sewage and Non-Water-Carried Waste Disposal. Oregon Administrative Rules, Chapter 340, Division 7, May 1978. p 97.
46. Hines, M. W., E. R. Bennett, and J. A. Hoehne. Alternate Systems for Effluent Treatment and Disposal. In: Proceedings of the Second National Home Sewage Disposal Symposium, Chicago, Illinois, December 1977. American Society of Agricultural Engineers, St. Joseph, Michigan, 1978. pp. 137-148.
47. Code of Waste Disposal Regulations - Part III. Utah State Department of Health, Sewers and Wastewater Treatment Works, Salt Lake City, 1977. 41 pp.